



Zone Termination Box - Modular

Category 6A - Category 6 - Fibre

Application/Product Description

The Zone Termination Box (ZTB) from HellermannTyton Connectivity is a compact and robust internal consolidation point. The ZTB has been designed to work as part of a Zone Cabling topology which allows for more flexibility in regards to MAC's within a structured cabling network.

This modular version of the ZTB allows for the use of keystone jacks and fibre adaptors, making it easier to configure each box to your bespoke requirements giving even greater flexibility.

Users can choose to have the box loaded with Cat6 UTP keystone jacks in a variety of colours, Cat6A shielded jacks or LC duplex / SC simplex fibre adaptors.

Features and Benefits

- Supports Category 6A, Category 6 and Fibre
- Uses HellermannTyton's Modular Connectivity
- Supports PoE when using Cat6A/Cat6 Keystone Jacks
- Accepts Shielded and Unshielded Jacks
- Accepts up to 12 cable lines
- 1.5mm mild steel for added strength
- Internal steel cross-member supports for increased impact resistance
- Compact size allows for installation in restricted spaces
- Removable lid for ease of termination/installation
- Lockable for security
- Fixing points to allow for installation on walls/risers, in ceilings, floors or under desk
- Grey powder coated finish for humidity and temperature protection
- Brush strips for easy cable entry/exit and debris free operation
- Integral cable anchor points
- Modular design allows user to mix and match desired connectivity i.e. 6x Cat6A & 6x LC Duplex OM4
- Port identification

Technical Data

Material	Powder Coated Mild Steel		
Colour	Grey		
Dimensions (mm)	H	W	D
	36	294	138.6



Modular ZTB Loaded with 12 x Cat6 UTP Jacks

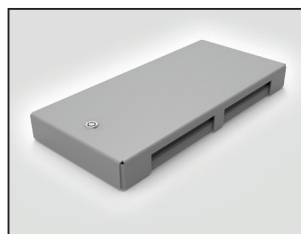

ZTB Closed View

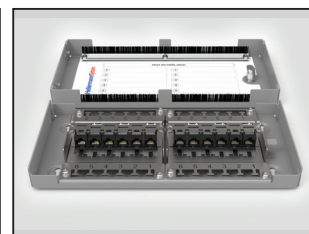

ZTB12J6BKXXX/GY

Order Information

Item Code	Description
ZTB12J6BKXXX/GY	Zone Termination Box Loaded with 12 Cat6 UTP Black Jacks
ZTB12SJ6AXXX/GY	Zone Termination Box Loaded with 12 Cat6A STP Jacks
ZTB12LCDGNXXX/GY	Zone Termination Box Loaded with 12 LC Duplex SM APC Adaptors
ZTB06SJ6A06LCDMG/GY	Zone Termination Box Loaded with 6x Cat6A STP Jacks + 6x LCD OM4

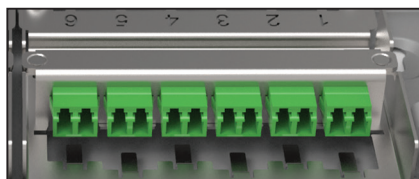

ZTB Modular array with LC Duplex adaptors – Available in SM, SM APC, OM3, OM4, OM5

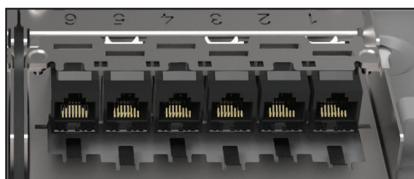

ZTB Modular array With Cat6 UTP Keystone Jacks – Various colours

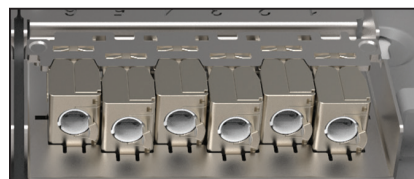

ZTB Modular array With Cat6A STP Keystone Jacks

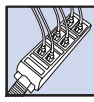

Technical Diagrams

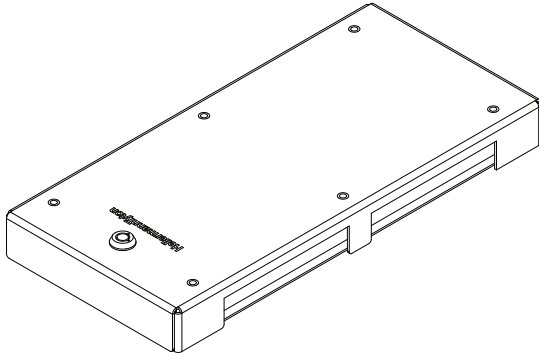

Closed ZTB

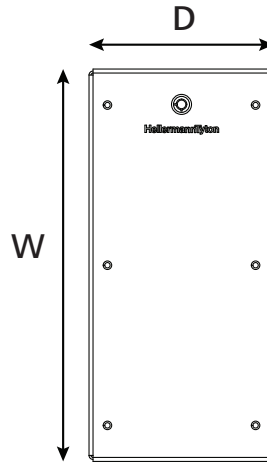

Front View



Side View

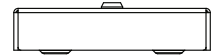

Top View