



# **Dome Closure Technical Datasheet**

Better Technology through Innovation

**MADE TO CONNECT**

## Delivering Performance through Meticulous Analysis

### Overview

Meeting the highest demands of optical and mechanical performance in the uncontrolled environment of outside plant fibre closures does not occur by accident. Countless hours of research, design, refinement and testing are invested into every product to ensure a lifetime of reliability in our sealed dome closures.

With over twenty years' experience in the design and development of sealed dome closures, HellermannTyton has fostered a deep insight into the measures needed to ensure their products provide complete and precise protection for each and every fibre housed, routed, managed and spliced inside every one of its extensive range of closures. Several national, regional and international product specifications and performance standards exist, which outline the minimum required performance levels for numerous aspects of a closure, including sealing, cable manipulation, temperature cycling and vibration.

This document outlines the considerable range of tests required to comprehensively evaluate both the mechanical and optical performance of a sealed dome closure. Some twenty tests are routinely performed on our sealed dome closure product set in accordance EN 50411-2-4 and EN 61753-111-7/8/9. These tests are grouped into five main categories, entitled:

- Tightness, optical and appearance performance criteria
- Mechanical sealing performance requirements
- Environmental sealing performance requirements
- Mechanical optical performance requirements
- Environmental optical performance requirements

The first of which are a series of performance criteria applied to the closure under test before, during and/or after the specific test has been applied. The remaining four sets of requirements evaluate both the mechanical and optical aspects of the closure.

The environmental conditions in which the closures are installed is also taken into consideration during the testing. Aerial or subterranean installation is responsible for determining the extremes of temperature that the closure is subjected to as well and the vibration profile. The following pages describe these in detail, however, in short our range of closures has been field proven for over two decades as being able to endure installation both above and below ground in a wide range of temperatures around the world.

The performance requirements for each of the requisite tests are contained in the performance standards and product specifications, however the test methodology is not. The tests are conducted in accordance with a wide range of referenced standards found in the ISO IEC 61300 family, each of which defines the precise way in which a specific aspect of the closure's performance is to be evaluated.

Jason James

Technical Director

BSI GEL86 & CENELEC TC/86A Committee Member

## Sealed Dome Closures Performance Requirements from EN 50411-2-4

Tightness, optical and appearance performance criteria

TEST	Requirement	Details	Results
<b>Sealing performance after test</b>	No emission of air bubbles indicating a leak	Method: EN 61300-2-38 Method A Test temperature: 23°C ± 3°C Test pressure: 40 kPa ± 2 kPa Immersion depth: Just below surface of water Duration: 15 min Pre-conditioning procedure: Sample should be conditioned to room temperature for at least 2 hours	Pass
<b>Pressure loss during test</b>	Difference in pressure before and after test shall be less than 2 kPa. Measurements taken at same atmospheric conditions	Method: EN 61300-2-38 Method B Test temperature: As specified by individual test Test pressure: 40 kPa ± 2 kPa at test temperature Pressure detector: Minimum resolution 0.1 kPa Pre-conditioning procedure: Sample should be conditioned to specified temperature at test pressure for at least 4 hours.	Pass
<b>Visual appearance</b>	No defects which would affect functionality of the closure	Method: EN 61300-3-1 Examination: Product shall be checked with naked eye.	Pass
<b>Change in attenuation</b>	Excursion losses: $\delta IL \leq 0.2\text{dB}$ at 1310 nm and 1550 nm per incoming fibre during test $\delta IL \leq 0.5\text{dB}$ at 1625 nm per incoming fibre during test  Residual losses: $\delta IL \leq 0.1\text{dB}$ at 1310 nm, 1550 nm and 1625 nm per incoming fibre after test	Method: EN 61300-3-3 Method 1 Wavelengths: 1310 nm ± 25 nm, 1550 nm ± 25 nm and 1625 nm ± 25 nm Source stability: Within ± 0.05dB over the measuring period Detector linearity: Within ± 0.05dB over the dynamic range to be measured Measurements required: Before, during and after the test Sampling rate: Every 10 min	Pass
<b>Transient loss</b>	Transient losses: $\delta IL \leq 0.5\text{dB}$ at 1550 nm per active circuit during test $\delta IL \leq 1\text{dB}$ at 1625 nm per active circuit during test  Residual losses: $\delta IL \leq 0.1\text{dB}$ at 1550 and 1625 nm per active circuit after test	Method: EN 61300-3-28 Wavelengths: 1550 nm ± 25 nm and 1625 nm ± 25 nm Source stability: Within ± 0.05dB over the measuring period Detector linearity: Within ± 0.05dB over the dynamic range to be measured Measurement required: Before, during and after the test Active circuit: 10 incoming fibres in series	Pass

### Mechanical sealing performance requirements

TEST	Requirement	Details	Results
<b>Vibration (Sinusoidal) for Category Subterranean</b>	Sealing performance after test Visual appearance	Method: EN 61300-2-1 Frequency: 10 Hz Amplitude: 3mm Duration: 10 days Temperature: 23°C ± 3°C Test pressure: 40 kPa ± 2 kPa Pre-conditioning: At least 2 hours to specified temperature	Pass
<b>Vibration (Sinusoidal) for Category Aerial</b>	Sealing performance after test Visual appearance	Method: EN 61300-2-1 Frequency range: 5 Hz – 500 Hz at 1 octave/min Amplitude / acceleration force: 3mm or 1gn maximum Cross-over frequency: 9 Hz Number of sweeps: 10 sweeps (5-500-5) Number of axes: 3 mutually perpendicular Temperature: + 23°C ± 3°C Test pressure: 0 kPa ± 2 kPa Pre-conditioning: at least 2 hours to specified temperature	Pass
<b>Cable Retention</b>	Pressure loss during test Sealing performance after test Visual appearance	Method: EN 61300-2-4 Temperature: -15°C ± 2°C and +45°C ± 2°C Load: (mm)/45*1000 N or 1000 N maximum Duration: 1 hour per cable Test pressure: 40 kPa ± 2 kPa Pre-conditioning: at least 4 hours to specified temperature	Pass
<b>Cable Bending</b>	Pressure loss during test Sealing performance after test Visual appearance	Method: EN 61300-2-37 Temperature: -15°C ± 2°C and +45°C ± 2°C Bending force: 30° Bending force application: 400mm from end of seal Number of bending cycles: 5 cycles Test pressure: 40 kPa ± 2 kPa Pre-conditioning: at least 4 hours to specified temperature	Pass
<b>Torsion/Twist</b>	Pressure loss during test Sealing performance after test Visual appearance	Method: EN 61300-2-5 Temperature: -15°C ± 2°C and +45°C ± 2°C Torque: 90° Force application: 400mm from end of seal Number of cycles: 5 cycles Test pressure: 40 kPa ± 2 kPa Pre-conditioning: at least 4 hours to specified temperature	Pass

<b>Impact (Free Fall)</b>	Sealing performance after test	Method: Temperature: Severity: Number of drops: Test pressure: Pre-conditioning:	EN 61300-2-12 method A -15°C ± 2°C and +45°C ± 2°C Drop height 75cm 1 0 kPa ± 2 kPa at least 4 hours to specified temperature	Pass
<b>Impact</b>	Pressure loss during test Sealing performance after test Visual appearance	Method: Temperature: Impact tool: Drop height: Impact locations: Number of impacts: Test pressure: Pre-conditioning:	EN 61300-2-12 method B -15°C ± 2°C and +45°C ± 2°C Steel ball of 1kg 2m 0°, 90°, 180° and 270° 1 per location 40 kPa ± 2 kPa at least 4 hours to specified temperature	Pass
<b>Crush Resistance</b>	Pressure loss during test Sealing performance after test Visual appearance	Method: Temperature: Load: Application area: Locations: Duration: Test pressure: Pre-conditioning:	EN 61300-2-10 -15°C ± 2°C and +45°C ± 2°C 1000 N 25cm² Centre of closure at 0° and 90° around longitudinal axis of closure 10 min 40 kPa ± 2 kPa at least 4 hours to specified temperature	Pass
<b>Re-entries</b>	Sealing performance after test Visual appearance	Test method: Temperature: Conditioning between each re-entry: Number of re-entries:	EN 61300-2-33 23°C ± 3°C Ageing of minimum 1 temperature cycle as specified in Change of Temperature 10	Pass

### Environmental sealing performance requirements

TEST	Requirement	Details	Results	
<b>Change of Temperature</b>	Sealing performance after test Visual appearance	Method: Extreme temperatures: Dwell time: Rate of change: Number of cycles: Test pressure:	EN 61300-2-22 -40°C ± 2°C and +65°C ± 2°C 4 hours 1°C/min 20 40 kPa ± 2 kPa	Pass
<b>Water Immersion</b>	Visual appearance	Test method: Temperature: Water column height: Duration: Test pressure:	EN 61300-2-23 +23°C ± 3°C 6m 7 days 0 kPa ± 2 kPa	Pass

### Mechanical optical performance requirements

TEST	Requirement	Details	Results
<b>Vibration (Sinusoidal)</b>	Transient loss Visual appearance	Method: EN 61300-2-1 Temperature: +23°C ± 3°C Frequency range: 5 Hz – 500 Hz at 1 octave/min Amplitude / acceleration force: 3mm or 1gn maximum Cross-over frequency: 9 Hz Number of sweeps: 10 sweeps (5-500-5) Number of axes: 3 mutually perpendicular Optical circuit: 10 live fibres placed in series	Pass
<b>Cable Bending</b>	Transient loss Visual appearance	Method: EN 61300-2-37 Test temperature: +23°C ± 3°C Bending force: 30° Bending force application: 400mm from end of seal Number of bending cycles: 5 cycles Optical circuit: 10 live fibres in series	Pass
<b>Torsion/Twist</b>	Transient loss Visual appearance	Method: EN 61300-2-5 Test temperature: +23°C ± 3°C Torque: 90° Force application: 400mm from end of seal Number of cycles: 5 cycles Optical circuit: 10 live fibres in series	Pass
<b>Intervention and Reconfiguration</b>	Transient loss Visual appearance	Method: EN 61300-2-33 Test temperature: +23°C ± 3°C Optical circuit: 10 live fibres in series	Pass

### Environmental optical performance requirements

TEST	Requirement	Details	Results
<b>Change of Temperature</b>	Change in attenuation Visual appearance	Test method: EN 61300-2-22 Low temperature: -40°C ± 2°C High temperature: +65°C ± 2°C Duration at temperature extreme: 4 h Rate of change of temperature: 1°C/min Number of cycles: 20 Measurements required: Before, during and after the test Recovery procedures: 4 h at normal ambient conditions	Pass

## Test procedures

### Mechanical sealing performance

Sealed dome closures, whether installed above or below ground need to keep the harshness of the environment on the outside. This series of performance tests exposes the closure to situations where the sealing performance is evaluated.

The main closure seal as well as the cable port seals, be they heatshrink or Cablelok, are vibrated, pulled, compressed, bent and twisted at elevated and frozen temperatures as well as being dropped and re-entered numerous times to ensure the integrity of the seals is maintained.

#### Vibration (Sinusoidal)

The samples were mounted onto the vibration machine using a mounting fixture and an air pipe was attached to the valve to apply a  $40 \text{ kPa} \pm 2 \text{ kPa}$  internal overpressure. The vibration test was performed at the specified frequencies and the air pressure value was monitored during testing. The samples were left to recover at room temperature for 2 hours then visually inspected prior to the sealing performance test being performed.

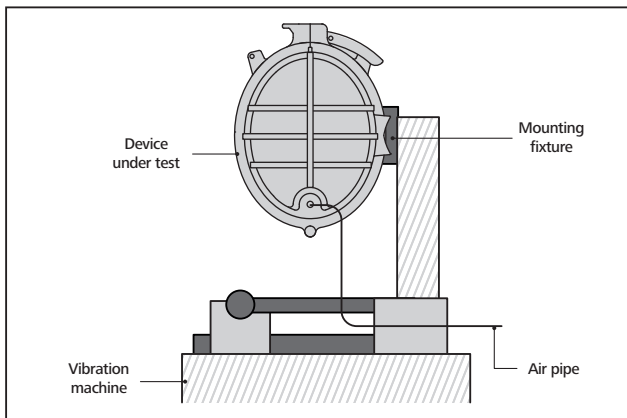

Illustration 1: Vibration

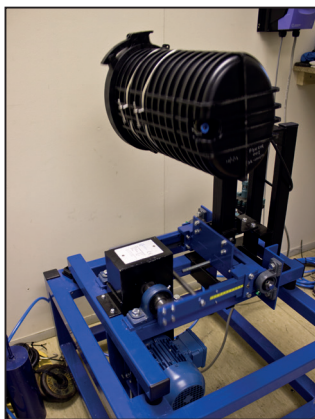

Image 1: Vibration

#### Cable Retention

The samples were preconditioned at  $-15^\circ\text{C}$  for 4 hours in an environmental chamber. The samples were then mounted onto a holding fixture inside the environmental chamber and an air pipe was attached to a valve at the bottom of the sample to apply  $40 \text{ kPa} \pm 2 \text{ kPa}$  internal overpressure. A force generator was attached to the cable to provide a specified force and the air pressure was monitored and recorded for period of 1 hour. The samples were left to recover in ambient conditions for 2 hours prior to performing a visual inspection and the sealing performance test.

The samples were preconditioned at  $45^\circ\text{C}$  for 4 hours and the above procedures were repeated at  $45^\circ\text{C}$ . The samples were left to recover in ambient conditions for 2 hours prior to performing a visual inspection and the sealing performance test.

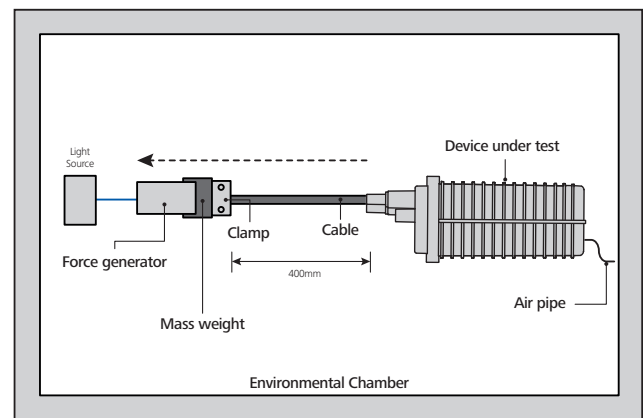

Illustration 2: Cable Retention

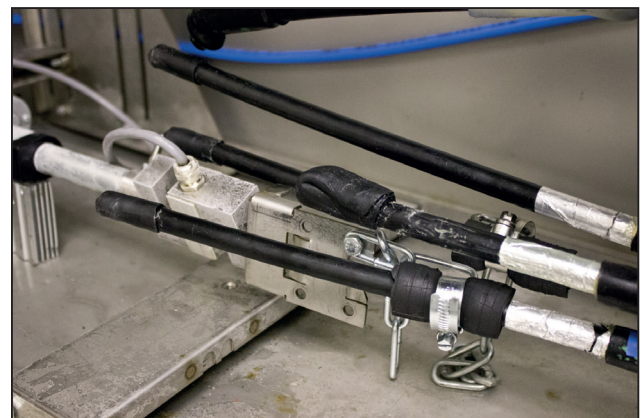

Image 2: Cable Retention

### Cable Bending

The samples were preconditioned at  $-15^{\circ}\text{C}$  for 4 hours in the environmental chamber and then mounted onto a holding fixture inside of the chamber where an air pipe was attached at the bottom valve to provide  $40\text{ kPa} \pm 2\text{ kPa}$  internal overpressure. After preparation, the cable was gently bent to  $30^{\circ}$  clockwise from its original position over a period of 15 seconds and the  $30^{\circ}$  position maintained for a period of 5 minutes. The cable was then bent from  $30^{\circ}$  to  $-30^{\circ}$  over a period of 15 seconds and then maintained at the  $-30^{\circ}$  position for 5 minutes. The cable was returned back to the original position to completing one bending cycle. This procedure was repeated until five bending cycles were completed and the air pressure was monitored during each cycle. On completion of bending test at  $-15^{\circ}\text{C}$  the samples were recovered in ambient conditions for 2 hours prior to performing a visual inspection and the sealing performance test.

The samples were preconditioned at  $45^{\circ}\text{C}$  for 4 hours and the above procedures were repeated to complete the bending test at  $45^{\circ}\text{C}$ .

On completion of the bending test at  $45^{\circ}\text{C}$  the samples were recovered in ambient conditions for 2 hours prior to a visual inspection and sealing performance tests being performed.

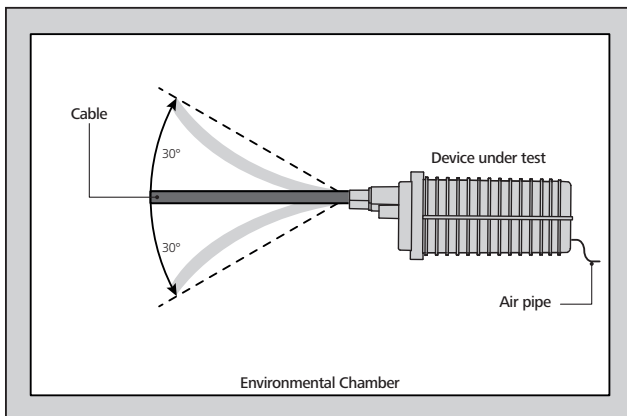

Illustration 3: Cable Bending



Image 3: Cable Bending

### Torsion/Twist

The samples were preconditioned at  $-15^{\circ}\text{C}$  for 4 hours in the environmental chamber. The samples were taken out of the chamber and attached onto a holding fixture and an air pipe was attached to the valve at the bottom of the sample to provide  $40\text{ kPa} \pm 2\text{ kPa}$  internal overpressure. A clamp was applied 400mm from the end of seal and a mass weight attached to the clamp to provide the specified tensile load. A twist cycle consisted of a motion of  $\pm 90^{\circ}$  being applied to the cable clamp; this cycle was repeated five times to meet the specification and the air pressure was monitored during each twist motion.

On completion of torsion/twist test at  $-15^{\circ}\text{C}$ , the samples were recovered in ambient conditions for 2 hours prior to a visual inspection and sealing performance tests being performed.

The closure samples were placed in the environmental chamber and preconditioned at  $45^{\circ}\text{C}$  for 4 hours and the above procedures were repeated to complete the torsion/twist test at  $45^{\circ}\text{C}$ . After the completion of torsion/twist test at  $45^{\circ}\text{C}$  the samples were recovered in ambient conditions for 2 hours prior to a visual inspection and sealing performance tests being performed.

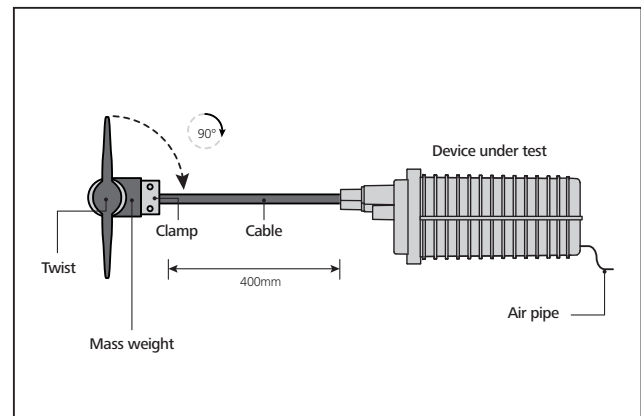

Illustration 4: Torsion / Twist



Image 4: Torsion / Twist



### Impact (Free Fall)

The samples were preconditioned at -15°C for 4 hours in the environmental chamber prior to a 2m cable being attached to the closure sample for pendulum drop. The closure was raised to a height of 75cm and then released to drop on the impact surface. After the completion of Impact (Free Fall) test at -15°C, the samples were recovered in ambient conditions for 2 hours prior to the sealing performance test being performed.

The samples were then preconditioned at 45°C in the environmental chamber for 4 hours and the above procedures were repeated to complete the Impact (Free Fall) test at 45°C. After the completion of Impact (Free Fall) at 45°C, the samples were recovered in ambient conditions for 2 hours prior to the sealing performance test being performed.

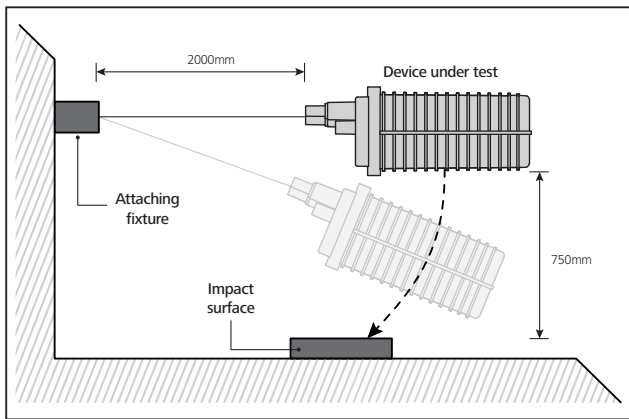

Illustration 5: Impact (free fall)

### Crush Resistance

The samples were preconditioned at -15°C for 4 hours in the environmental chamber prior to being placed on a metal plate inside the chamber and an air pipe being attached to the valve at the bottom of the closure to provide 40 kPa ± 2 kPa internal overpressures. A 25cm<sup>2</sup> metal pad was attached to force generator and this was placed on the top of the closure. Force was smoothly applied to the pad at 0° location until it reached 1000N at which point it is maintained for a period of 10 minutes while the air pressure was monitored. The closure sample was then rotated 90° along the longitudinal axis, defined as 90°, for a second crush test to be performed whilst monitoring the air pressure. On completion of the crush test at -15°C the closure samples were recovered in ambient conditions for 2 hours prior to performing the visual and sealing performance tests.

On completion of the visual inspection and sealing performance tests the samples were preconditioned at 45°C for 4 hours in the environmental chamber. The above procedures were repeated for the crush test. On completion of the crush tests at 45°C the closures were recovered in ambient conditions for 2 hours prior to a visual inspection and sealing performance test being completed.

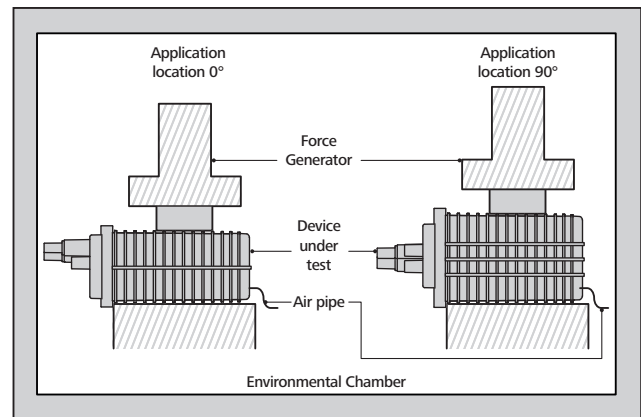

Illustration 6: Crush Resistance

### Impact

The samples were pre-conditioned at -15°C for 4 hours in the environmental chamber then taken out from the chamber and placed under a 2m steel pipe. An air pipe was attached to the valve at the bottom of the samples to provide 40 kPa ± 2 kPa internal over-pressures. A 1 kg steel ball was held at the top of the pipe then released to impact the closure samples through the pipe. This was defined as the 0° location for the impact test. After the first impact, the closure samples were rotated 90° along the longitudinal axis and another impact was performed. This was defined as the 90° location of the impact test. The 90° rotation was repeated twice more to complete the impact at 180° and 270° locations. During the impact tests, temperature and air pressure were monitored and recorded. After the completion of impact tests at -15°C, the samples were recovered in ambient conditions for 2 hours then visually inspected for appearance performance. Furthermore, sealing performance was tested after visual inspection.

After the visual inspection and sealing performance test for the impact tests at -15°C, the samples were pre-conditioned at 45°C for 4 hours in the environmental chamber. Then the above procedures were repeated to complete the impact tests at 45°C. After the completion of impact tests at 45°C, the samples were recovered in ambient conditions for 2 hours then visually inspected for appearance performance. Furthermore, sealing performance was tested after visual inspection.

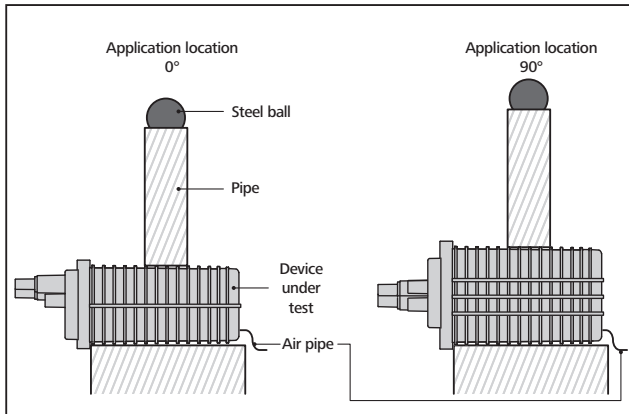

Illustration 7: Impact

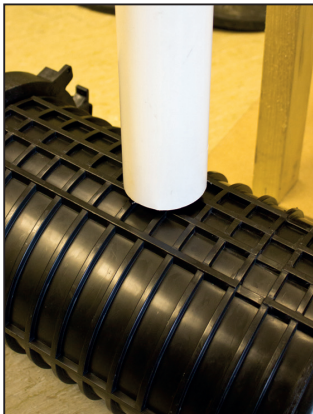

Image 5: Impact

### Re-entries

The procedure is described below:

- Perform initial visual inspection and sealing performance test.
- Perform one temperature ageing cycle that is specified in Change of Temperature test. On completion of the ageing cycle the closure is recovered in ambient conditions for 4 hours.
- Disassemble the closure to the point that the cable inside the closure can be observed.
- Re-install the closure.
- Perform a visual inspection and sealing performance test.
- Repeat procedure until 10 re-entries have been completed.

It took 10 working days to complete 10 re-entry operations per closure.

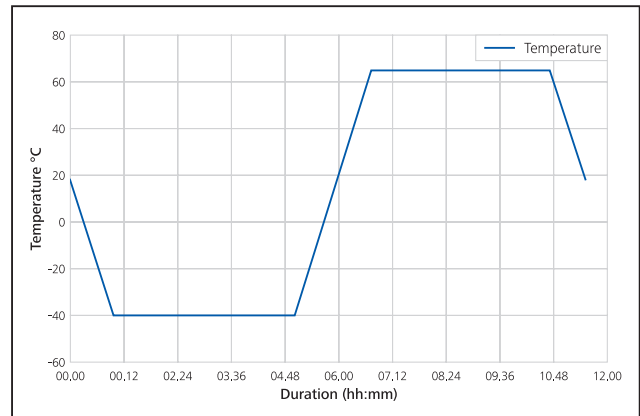

Table 1: Profile of a temperature cycle

### Environmental Sealing Performance

The environmental sealing tests subject the closure to a swept temperature cycle of some twenty repetitions to simulate a lifetime of expose to hot and cold environments.

The accelerated testing stresses the materials to determine if they are suitable for extended life operations, be that above or below ground. Water immersion is a common occurrence and compliance with this requirement is one of the most arduous. Material choice and thickness play a critical role.

At HellermannTyton we test with a 60% margin above the regulation five metre to guarantee trouble-free operation.

#### Change of Temperature

The closure was placed in the environmental chamber and an air pipe was attached to provide 40 kPa ± 2 kPa internal overpressure and a total of 20 temperature cycles were implemented. On completion of 20 temperature cycles the closure was recovered in ambient conditions for 2 hours prior to being visually inspected and sealing performance tested.

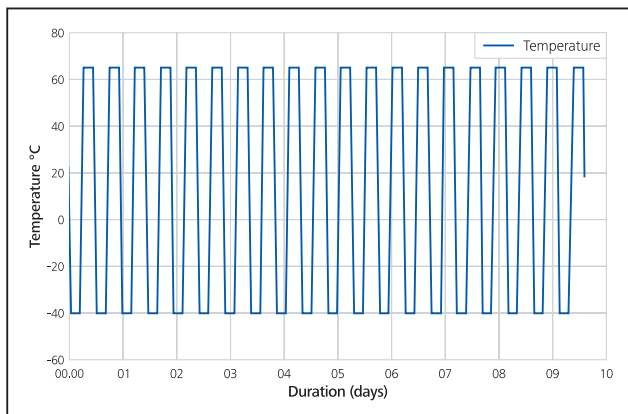

Table 2: Profile of 20 temperature cycles



Image 6: Environmental Chamber shown with door open

#### Water Immersion

The closure was placed into a water chamber and the water pressure set to 78.43 kPa which is equivalent to 8m water column height. The closure was immersed in the water chamber for 7 days and the temperature maintained as ambient temperature. On completion of water immersion the closure was taken out of the water chamber and visually inspected.

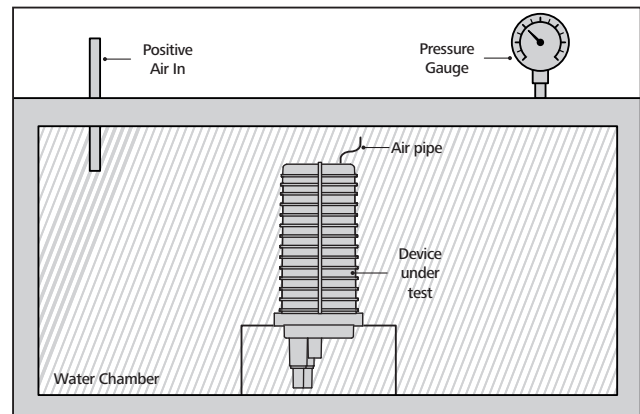

Illustration 8: Immersion test on an FDN closure



Image 6: Immersion

### Mechanical Optical Performance

Whilst the previous sealing tests subject the closure to mechanical stresses at various temperatures, the mechanical optical requirements are performed at room temperature.

The same mechanical stresses are performed as previous, but with these tests the optical losses of the fibres are measured for insertion loss and transient losses. These measurements are performed using state of the art laser sources and power metres or optical time domain reflectometry. Ensuring minimum optical loss variation during the re-entry or reconfiguring of a closure is a key aspect of its design and one that is rigorously tested.

#### Vibration (Sinusoidal)

The closure was mounted on the 600mm Sliptable for three axes vibration and the drop cable was connected with the back reflection meter to monitor any transient loss at both 1550 nm and 1625 nm wavelength. During the vibration test the acceleration force was monitored to meet the amplitude/acceleration force requirements for the vibration test and the transient loss was monitored in all three axes. On completion of the vibration test in all three axes the sample was recovered in ambient conditions for 2 hours and the final attenuation was measured.

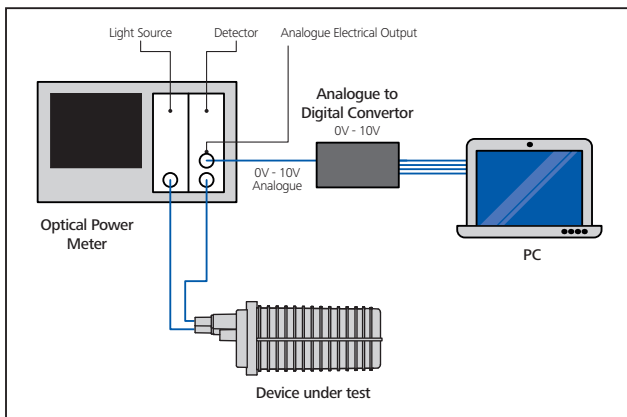

Illustration 9: Transient Loss

#### Cable Bending

An initial attenuation measurement was taken after preconditioning and the cable was bent to 30° anticlockwise over a period of 15 seconds and the bend was maintained for 5 minutes. The cable was then bent to 30° clockwise over a period of 15 seconds and the bend was maintained for another 5 minute period. The cable was then released back to its original position completing the first bending cycle. This procedure was repeated four times to complete the five required bending cycles and the transient losses were monitored and recorded during each cycle. The sample was then recovered for 2 hours prior to a visual inspection being performed and a final attenuation measurement taken to review for any residual losses.

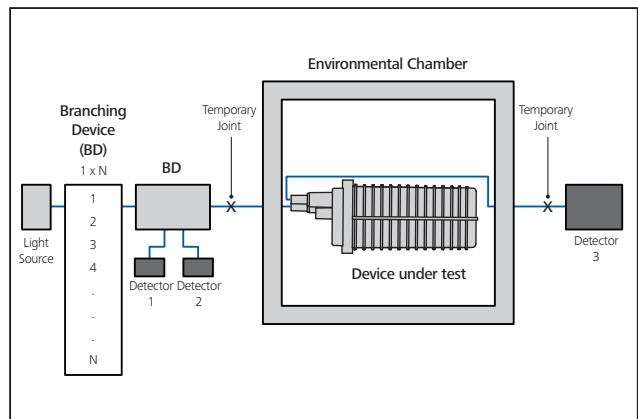

Illustration 10: Change in Attenuation

#### Torsion/Twist

The closure was attached to the mounting fixture after 2 hours preconditioning and a clamp was applied 400mm away from the end of seal to attach the tensile load. A mass weight was attached to the clamp to provide specified tensile load and the optical attenuation was measured as the reference for any transient loss test. A twist motion of  $\pm 90^\circ$  was applied to cable clamp for a complete twist cycle and the twist cycle was repeated five times to meet the specification. Transient losses were monitored during each twist motion and after five twist cycles the optical attenuation was measured for any residual losses and the closure was examined visually to inspect any degradation of the sample.

#### Intervention and Reconfiguration

The manipulations included the following steps:

- Moved the closure to working place and mounted on the holding fixture.
- Opened the closure by removing the cover.
- Adding splicing trays.
- Cut a splice and re-splice the fibre cable.
- Closed the closure by installing the cover.

The transient losses were monitored and recorded during the intervention and reconfiguration procedures.

### Environmental Optical Performance

The optical evaluation of a number of fibre circuits in series in a sealed dome closure over a sequence of twenty sweep cycles tests closure as well as fibre management systems to the realities of their installation environments.

The ten day test (approx.) measures the change in attenuation of the system at the common wavelength of 1310 nm and 1550 nm as well as the more sensitive wavelength of 1625 nm to ensure product design does not adversely influence optical losses under normal operating conditions.

#### Change of Temperature

The samples were preconditioned in ambient conditions for 2 hours then placed into the environmental chamber. Drop cables from the closure were connected with four channels on the panel of the back reflection meter and the attenuation was measured as the reference for attenuation monitoring. Twenty temperature cycles were applied to the closure in the environmental chamber and the attenuation was monitored at 1 point/10 min sampling rate. On completion of temperature cycling the samples were recovered in ambient conditions for 4 hours and a final attenuation measurement was performed to validate the residual losses.

Equipment list:

- Environmental chamber: Binder MK720
- Light source power metre: JGR MBR5 Backreflection Meter

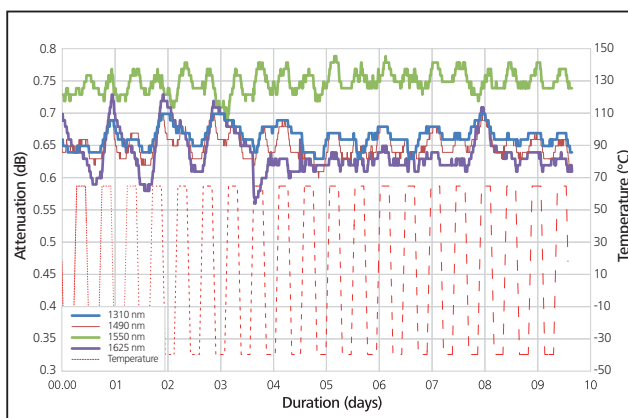

Table 3: Monitored Change in Attenuation of a Closure Sample

### Broadband Fibre Dome Closure

Dimensions and Capacity (based on SC-B trays)

SPLICE TYPE	CLOSURE LENGTH	BASE DIMENSIONS	CLOSURE RANGE									
			UFC			FDN		FML		CFN	FRBU	FST
			IR		TUBED	IR	TUBED	IR	TUBED			
			Double	Single								
		Width (mm) D1 x D2	275 x 310			222 x 312		220 x 275		250 x 180	130 x 130	110 x 110
<b>3A</b>	<b>S</b>	Length (mm)								335		
		Tray Qty								12		
		Max Splice								144		
	<b>MX</b>	Length (mm)									360	
		Tray Qty									3	
		Max Splice									72 / 144**	
	<b>M</b>	Length (mm)								410		
		Tray Qty								24		
		Max Splice								288		
	<b>A</b>	Length (mm)	400			455		400			435	310
		Tray Qty	6			12 (1)   12 (2)		6 (1)			6 (6)	3 (1) ‡
		Max Splice	144			144   288*		144*			72 / 144**	36
	<b>AB</b>	Length (mm)				561						
		Tray Qty				24 (2)   18 (3)						
		Max Splice				288   432*						
	<b>B</b>	Length (mm)	549			663		598			505	
		Tray Qty	48 (4)	24 (2)		48 (4)	24 (4)	36 (6)	24 (4)		6 (6)	
		Max Splice	576	288		576	576*	432	576*		72 / 144	
	<b>BC</b>	Length (mm)	598					668				
		Tray Qty	72 (6)	36 (3)	36 (12)			48 (4)				
		Max Splice	864	432	864			476				
	<b>C</b>	Length (mm)	749			789		748				
		Tray Qty	120 (10)	60 (5)	72 (12)	72 (6)	36 (6)	60 (5)	36 (6)			
		Max Splice	1440	720	1728*	864	864*	720	864*			

‡ (Tray pack ordering multiple)

\* Based on maximum splice protector length of 45mm

\*\* Splice Capacity Achieved when double stacking on a tray.



# Broadband Connectivity Products

## Sealed Dome Closures



### FML Closures

The FML is a medium sized round closure with 12 round ports and 1 oval port.

Supplied in both IR and tubed versions, the FML offers a maximum splice capacity of up to 864 fibres (using 3A splices).

More information at:  
[www.htdata.co.uk/site/products/fml-closures](http://www.htdata.co.uk/site/products/fml-closures)

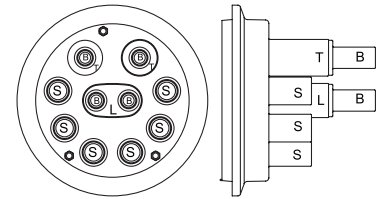

FML Port Base Configuration



### CFN Closures

The CFN is a small sized oval closure available in 2 base types, the 19 port and the 27 Port.

The CFN offers a maximum splice capacity of up to 144 fibres (using 3A splices).

More information at:  
[www.htdata.co.uk/site/products/cfn-closures](http://www.htdata.co.uk/site/products/cfn-closures)

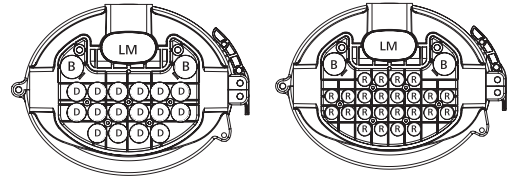

CFN 19 Port Base Configuration

CFN 27 Port Base Configuration



### FRBU Closures

The FRBU is a compact closure from HellermannTyton with 3 base sizes available, 9 port, 11 port and 16 port.

With 8, 10 or 16 round ports and 1 oval port, the FRBU offers a maximum splice capacity of up to 144 fibres (using 3A splices).

More information at:  
[www.htdata.co.uk/site/products/frbu-closures](http://www.htdata.co.uk/site/products/frbu-closures)

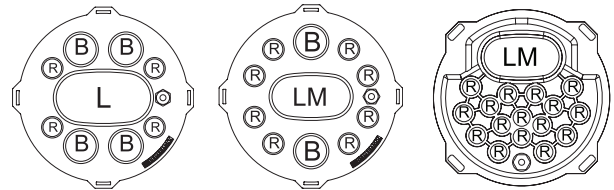

FRBU 9 Port Base Configuration

FRBU 11 Port Base Configuration

FRBU 16 Port Base Configuration



### FST Closures

The FST closure is the smallest in the HellermannTyton range with 2 base sizes available, the 4 port and the 13 port.

With 3 or 12 round ports and 1 oval port, the FST closure offers a maximum splice capacity of up to 36 fibres (using 3A splices).

More information at:  
[www.htdata.co.uk/site/products/fst-closures](http://www.htdata.co.uk/site/products/fst-closures)

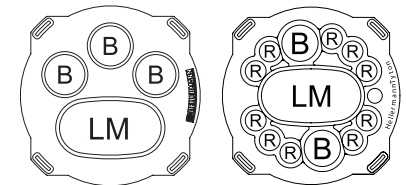

FST 4 Port Base Configuration

FST 13 Port Base Configuration (Cablelok only)

## Closure Material Specification

CLOSURE RANGE		BASE	COVER	CLAMP
UFC	IR	Cablelok	Polypropylene	Glass Filled Polyamide
		Heatshrink	Polypropylene	Glass Filled Polyamide
	TUBED	Cablelok	Polypropylene	Glass Filled Polyamide
		Heatshrink	Polypropylene	Glass Filled Polyamide
FDN	IR	Polypropylene	Polypropylene	Glass Filled Polyamide
	TUBED	Polypropylene	Polypropylene	Glass Filled Polyamide
FML	IR	Polypropylene	Polypropylene	Glass Filled Polyamide
	TUBED	Polypropylene	Polypropylene	Glass Filled Polyamide
CFN	IR	Polypropylene	Polypropylene	Polypropylene
FRBU	9 Port	Polyamide and Acrylonitrile Butadiene Styrene	Polypropylene	Polypropylene
	11 Port	Polyamide and Acrylonitrile Butadiene Styrene	Polypropylene	Polypropylene
	16 Port	Polypropylene	Polypropylene	Polypropylene
FST	4 Port	Polypropylene	Polypropylene	Polypropylene
	13 Port	Polypropylene	Polypropylene	Polypropylene



## Cablelok

### Overview of Cablelok

Cablelok is a mechanical seal manufactured from external grade flexible polychloroprene. There are 6 Cablelok port sizes which cover a cable range of 1.7mm – 29.0mm including a port plug for blocking unused drop ports.

More information at:

[www.htdata.co.uk/site/products/cablelok](http://www.htdata.co.uk/site/products/cablelok)



B Series Cablelok

### Maximum and minimum cable range

#### Port Type and Cable Size

The table below shows the port types and the cable sizes that can be used in that port using Cablelok and heatshrink sealing methods.

		OVAL		ROUND				
		L	LM	T	S	B	R	D
CABLE RANGE	Cablelok	2 x 5.5 - 20.0 mm	2 x 4.0 - 15.0 mm	15.5 - 29.0 mm	5.0 - 20.0 mm	4.8 - 16.5 mm	1.7 - 9.5 mm	10-12 mm
	Heatshrink	2 x 12.0 – 24.0	2 X 8.0 – 22.0*	12.0 – 35.0	12.0 – 26.0	6.0 – 19.0*	4.0 – 11.0* (FRBU only)	N/A

\* The CFN is unsuitable for use with Heatshrink.

#### Fibre Splice Closures

This table lists the fibre splice closures available and their port counts. The port count along with the table above listing the port cable sizes will help you in deciding which size Cablelok will work best for your application.

Port counts with additional numbers denote ports with multiple port size options. For example an oval port can present 1 x L-Port or 2 x S-ports.

Please refer to base port diagrams on the product pages in the Broadband Catalogue for further explanation.

		CLOSURE RANGE										
		UFC	FDN		FML	CFN		FRBU			FST	
Total Port Count		30	59	16	13	19	27	16	11	9	13	4
Oval	L	0 / 1	0 / 1	0 / 1	0 / 1	0	0	0	0	1	0	0
	LM	1	0	0	0	1	1	1	1	0	1	1
Round	T	0 / 2	0 / 2	0 / 2	0 / 2	0	0	0	0	0	0	0
	S	8 / 10	2 / 4	9	6	0	0	0	0	0	0	0
	B	16	0 / 2	0 / 4	2 / 4	2	2	0	2	4	2	3
	R	0	52	0	0	0	26	16	8	4	10	0
	D	0	0	0	0	18	0	0	0	0	0	0

## Fibre Optic Splice Trays

### Dimensions and Capacity

HellermannTyton offer a wide selection of fibre optic splice trays which are compatible with the variety of closures and enclosures available. Splice trays from the Hellipse and Integrated Routing (IR) ranges are supplied in packs of 6, this excludes the IR-SC trays, which are supplied in packs of 12. Trays from the Hellapon and Hellamass ranges are supplied in singular units. Multi-Ribbon trays are supplied in a packs of 3. The following fibre optic splice trays from HellermannTyton accept a range of splice inserts or splitter bridges which can house different

numbers and types of splice protectors and optical splitters on the trays; SE-MKI, SE-MKII, Compact SE, 900µm IR, Hellamass Large, Hellapon Small and Medium Style C, Hellipse NZDF SE-B and SE-A.











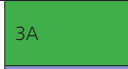



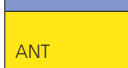

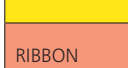

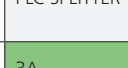

The table below illustrates which bridge inserts are compatible with which splice trays and also the maximum number of splices each tray can accommodate using that insert. The fibre splice capacities are calculated on a single stack basis unless otherwise stated.

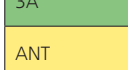
TRAY TYPE		IR							TUBED															
		UFC, FDN, FML			CFN	UFC, FDN, FML			CFN	UFC		FRBU		FRBU / FST	UFC, FDN, FML									
		Single Element				Single Circuit				Multi-Ribbon	Hellamass	Hellapon			Hellipse									
		SE MKI	SE MKII	900µm IR	Compact SE	SC-B MKII	SC-B MKI	SC	Compact SC-B		Large	Style C	Style A & B	Small	SE-B	SE-A	SC-1	SE-B	SE-A					
<b>Dimensions W x H x D (mm)</b>		148 x 125 x 7	150 x 124 x 7	171 x 145 x 14	30 x 109 x 7	150 x 124 x 3.5	148 x 125 x 3.5	30 x 109 x 3.5	182 x 148 x 14	145 x 440 x 19	96 x 235 x 7		85 x 158 x 9	195 x 148 x 7	182 x 148 x 7	184 x 148 x 3.5	184 x 148 x 7	202 x 148 x 7						
BRIDGE TYPE	Recov. Ø d max.	CAPACITY																						
3A	Heat Shrinkable	2.4	12	36	12	12	4	12	36	144	12	16	12	24	24	8	12	12						
	3A Splitter Bridge	2.4	8†	-	8†	-				12†	8†	-	8†	-				8†						
	3A Splitter/Splice Bridge	2.4	✓	✓	-	✓	-																	
6A	Heat Shrinkable	1.6	18	-	-				216	-		18	-				18							
Crimp (ANT)	Crimp (ANT)	-	24	-	24	12	4	12	-	288	24	24	24	-		8	24							
	ANT Splitter Bridge	-	14†	-	14†	-				14†	14†	14†	-				14†							
	ANT Splitter/Splice Bridge	-	✓	✓	-	✓	-																	
Ribbon	Moulded Ribbon 8 & 12 Fibre		-																					
	4 Way Ribbon	4.5 x 3.8	24"	48"	-	48"	-																	
	6 Way Ribbon	4.5 x 3.9	-																					
	Splitter / Ribbon	4.75	8	8	-	8	-				96	-		8	-				8	8				
<b>4 Way PLC Splitter 4 x 4x4x40</b>			✓	✓	✓	-											✓	✓	-	✓	✓	-	✓	✓

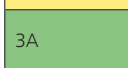
† Figures given are for 1 x Splitter bridge and 1 x 3A or ANT Splice bridge. Maximum Splitter/PON Device Size is 60 x 7 x 4 mm.

\*\* Based on 12 Fibre Intermittently Bonded Ribbon Fibres.

### Overview of Splitter/Splice Protector Holders

TYPE		Description	Compatible Trays	Colour
	<b>BRIDGE-3A</b>	Splice Protector Holder		Green
	<b>BRIDGE-6A</b>			Blue
	<b>BRIDGE-CRIMP</b>			Yellow
	<b>BRIDGE-MECH</b>			Red
	<b>BRIDGE-PLC-4WAY</b>	4 way Splitter		White
	<b>BRIDGE-SP/3A</b>	Splitter/Splice		Green
	<b>BRIDGE-SP/ANT</b>			Yellow
	<b>BRIDGE-3A/SP64-10</b>			Green
	<b>BRIDGE-ANT/SP64-10</b>			Yellow
	<b>BRIDGE-RIBBON-4WAY</b>	Intermittently Bonded Ribbon Splice		Green
	<b>BRIDGE-RIBBON-6WAY</b>			Multi-Ribbon Tray

All dimensions in mm. Subject to technical changes.

TYPE		BRIDGE-SP/3A	BRIDGE-SP/ANT	BRIDGE-3A/SP64-10	BRIDGE-ANT/SP64-10	BRIDGE-PLC-4WAY	
<b>No. of Splitters</b>		2	2	1	1	4	
<b>MAX Device Size (mm)</b>		60 x 7 x 4		60 x 12 x 4		40 x 4 x 4	
<b>Splitter Capacity</b>	<b>Splitter Type</b>	<b>Size (mm)</b>					
	250um	1:2	45 x 4.5 x 4	✓	✓	-	
		1:4	40 x 4 x 4	✓	✓	-	✓
		2:4	45 x 4.5 x 4			-	
		1:8	40 x 4 x 4	✓	✓	-	✓
		2:8	45 x 4.5 x 4			-	
		1:16	45 x 4.5 x 4	✓	✓	-	
		2:16	60 x 7 x 4			-	
		1:32	50 x 7 x 4	✓	✓	✓	✓
		2:32	65 x 7 x 4			-	
	600um	1:2			-		
		1:4			-		
		1:8			-		
		1:16			-		
		1:32			-		
	900um	1:2		✓		-	
1:4		60 x 7 x 4	✓	✓	-		
1:8		60 x 7 x 4	✓	✓	-		
1:16		60 x 12 x 4			✓	✓	
1:32		80 x 20 x 4			-		
<b>Splice Capacity</b>		2	2	2	2	N/A	
<b>MAX Recovered Diameter</b>		2.4	-	2.4	-	N/A	

# Broadband Connectivity Products

## Sealed Dome Closures

### Overview of Fibre Optic Splice Trays

#### Tubed Trays

##### Multi-Ribbon



**1** Multi-Ribbon  
(Shown with moulded fins.)

##### Hellamass



**2** Hellamass Large  
(Shown with 12 x 3A or ANT splice bridge inserts.)

##### Hellapon

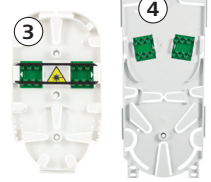

**3** Hellapon Small  
(Shown with 2 x splice bridge positions.)



**4** Hellapon Medium Style B  
(Shown with 2 x splice bridge positions.)

##### Hellipse



**5** Hellipse SMF SE-A  
(Shown with moulded fins.)

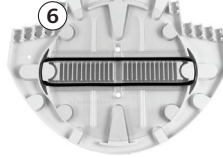

**6** Hellipse SMF SE-B  
(Shown with moulded fins.)



**7** Hellipse NZDF SC-1  
(Shown with moulded 3A or ANT splice bridges.)



**8** Hellipse NZDF SE-A  
(Shown with 2 x splice bridge positions or 1 x splice bridge and splitter/ribbon insert.)

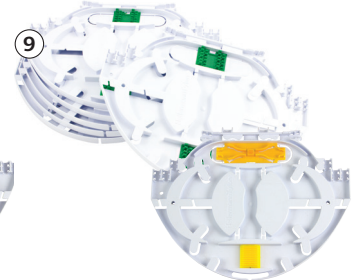

**9** Hellipse NZDF SE-B  
(Shown with 2 x splice bridge positions or 1 x splice bridge and splitter/ribbon insert.)

#### Integrated Routing Trays

##### Single Element SE-IR MKI and MKII



**1** SE-IR MKII  
(Shown with 3A splice bridges.)

**2** SE-IR MKI  
(Shown with 3A splice bridge and splitter bridge.)

**3** 900µm IR Tray  
(Shown unloaded.)

**4** SE-IR MKI  
Trays can accommodate variety of splice bridge inserts or splitter bridges in two locations. Range of coloured trays available.)

**5** Compact SE-IR  
Only compatible with CFN. (Shown with 2 x ANT, 2 x Ribbon and 2 x 3A splice bridges)

##### Single Circuit SC-B-IR MKI and MKII and SC-IR

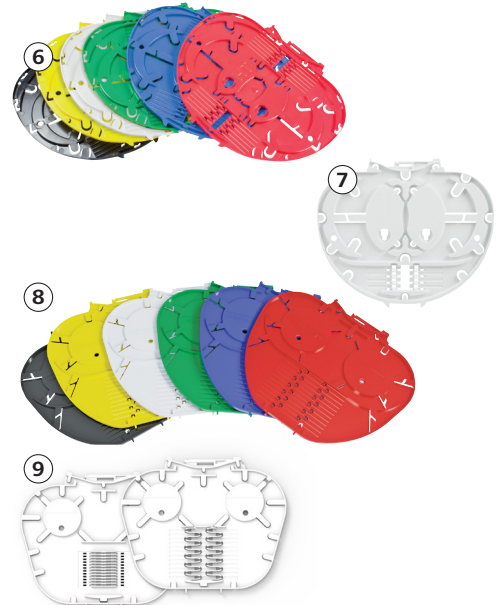

**6** SC-B-IR MKI  
(Shown with 12 x 3A moulded splice fins in range of colours.)

**7** SC-IR  
(Shown with 6 3A or ANT moulded splice fins.)

**8** SC-B-IR MKII  
(Shown with 12 x 3A moulded splice fin in range of colours.)

**9** Compact SC-B  
Only compatible with CFN. (Shown with 6 x ANT or 3A moulded splice fins.)



# HellermannTyton

**HellermannTyton Data Ltd – UK**

Waterside House,  
Edgar Mobbs Way  
Northampton NN5 5JE

Tel.: +44 1604 707 420

Fax: +44 1604 705 454

Email: [sales@htdata.co.uk](mailto:sales@htdata.co.uk)

[www.htdata.co.uk](http://www.htdata.co.uk)