



HTC Series Mounting Hardware

Faceplates, Modules, Blanks & Back Boxes

Application/Product Description

The HTC Series of mounting hardware has been designed to complement HellermannTyton's new HTC Series CAT6A and CAT6 connectivity product lines. This range features a full suite of single and double gang faceplates in a variety of styles, compatible blanks, modules and backboxes.

Features and Benefits:

- Made from ABS
- Faceplates Available in single & double gang
- Colour Consistent range
- Variety of Faceplate styles
- Fixing screws inclusive were applicable
- Plastic free packaging
- Bulk packed to reduce carbon footprint

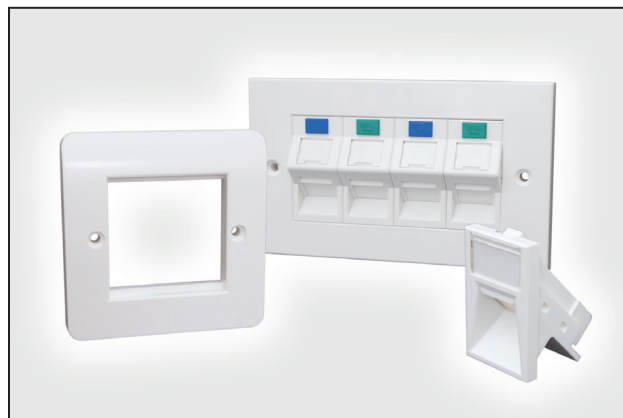

Mounting Hardware Selection

HTC Series Faceplates

Technical Data

Style	Office						Bevelled						Flat					
	Single Gang			Double Gang			Single Gang			Double Gang			Single Gang			Double Gang		
Dimensions (mm)	H	W	D	H	W	D	H	W	D	H	W	D	H	W	D	H	W	D
Compatible Hardware	HTC-C6U-EM30/WH - CAT6 50x25mm Euro Module																	
Compatible Hardware	HTC-EMA50/WH - Unloaded CAT6 50x25mm Angled Module																	
Outlet Capacity (max)	2			4			2			4			2			4		
Materials	ABS+PC						ABS						ABS					
Weight (g)	30			40			30			40			30			40		
Box Quantity	30 pcs						30 pcs						30 pcs					
Available Colours	White & Grey (DDA Part M)						White						White					
Item Code	HTC-FP1GOS30/WH			HTC-FP2GOS30/WH			HTC-FP1GBV30/WH			HTC-FP2GBV30/WH			HTC-FP1GFL30/WH			HTC-FP2GFL30/WH		
	HTC-FP1GOS30/DDA			HTC-FP2GOS30/DDA														

Technical Diagrams

Office Single

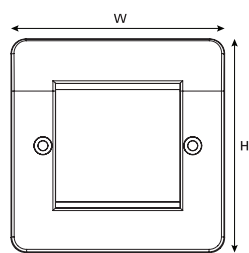

Front view

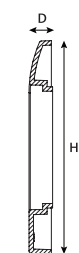

Side view

Office Double

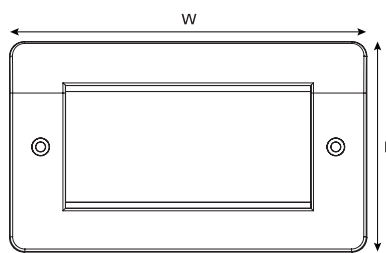

Front view

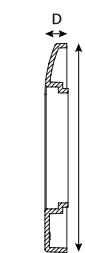

Side view

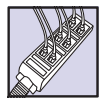

Bevelled Single

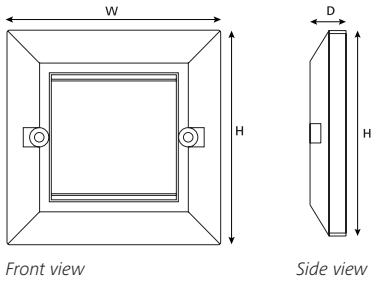

Bevelled Double

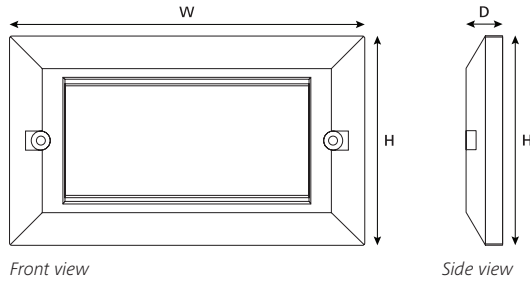

Flat Single

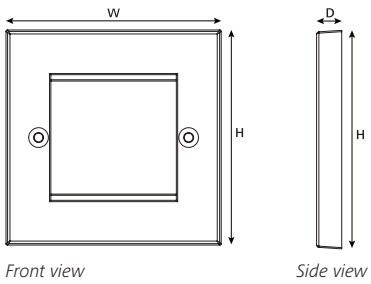

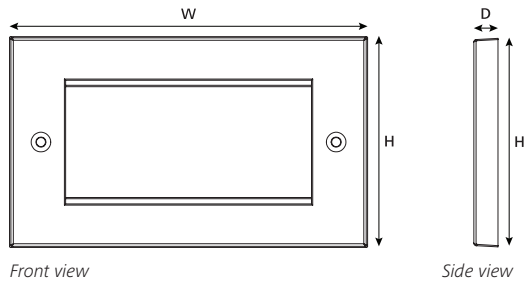

Flat Double



HTC Series Angled Modules

Technical Data

Style	EURO			LJ6C		
						
Dimensions (mm)	H	W	D	H	W	D
	50	25	32	38.5	25	30
Compatible Hardware	HTC-C6AS-KJ12 - CAT6A Tool Free Jack					
	GSTJC6U - CAT6 UTP Keystone Jack					
Material	ABS					
Weight (g)	12			11		
Box Quantity	50 pcs					
Available Colours	White					
Item Code	HTC-EMA50/WH			HTC-6CA50/WH		

Technical Data

Euro Module

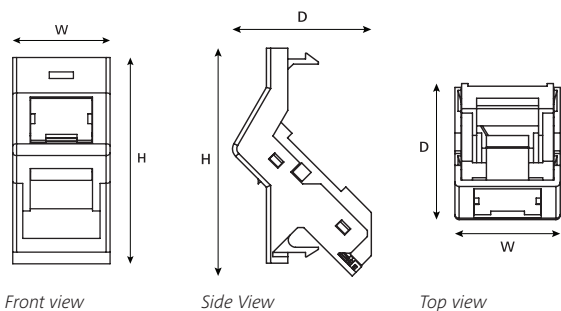

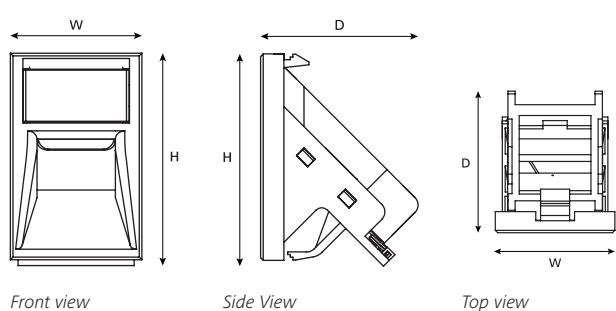

LJ6C Module

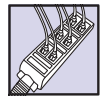



HTC Series Blanks

Technical Data

Style	Half Blank			Quarter Blank			
							
Dimensions (mm)	H	W	D	H	W	D	
	50	25	5	50	12.5	5	
Compatible Hardware	HTC Series Office Style, Bevelled and Flat						
Material	ABS						
Weight (g)	5			3			
Box Quantity	100 pcs						
Available Colours	White						
Item Code	HTC-FPBH100/WH			HTC-FPBQ100/WH			

Technical Data

Half Blank

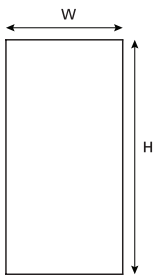

Front view



Side View

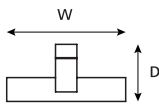

Top view

Quarter Blank

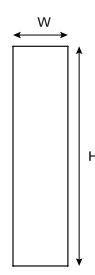

Front view

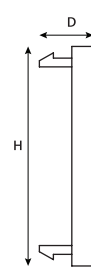



Side View



Top view

HTC Series Back Boxes

Technical Data

Style	27mm			37mm							
	Single Gang			Single Gang			Double Gang				
											
Dimensions (mm)	H	W	D	H	W	D	H	W	D		
	86	86	27	86	86	37	86	146	37		
Compatible Hardware	HTC Series Office Style, Bevelled and Flat										
Material	ABS										
Weight (g)	60			70			80				
Box Quantity	10 pcs										
Available Colours	White										
Item Code	HTC-BB1G2710/WH			HTC-BB1G3710/WH			HTC-BB2G3710/WH				

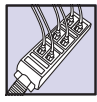

Technical Data

27mm Single

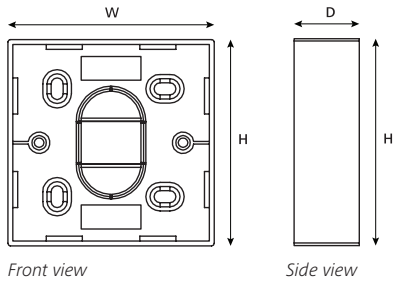

37mm Single

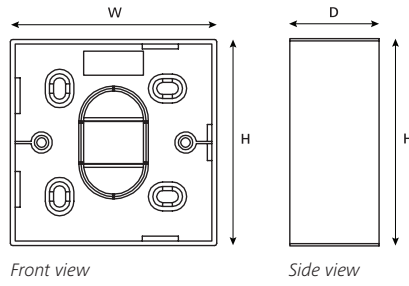

37mm Double

