

2010/2011

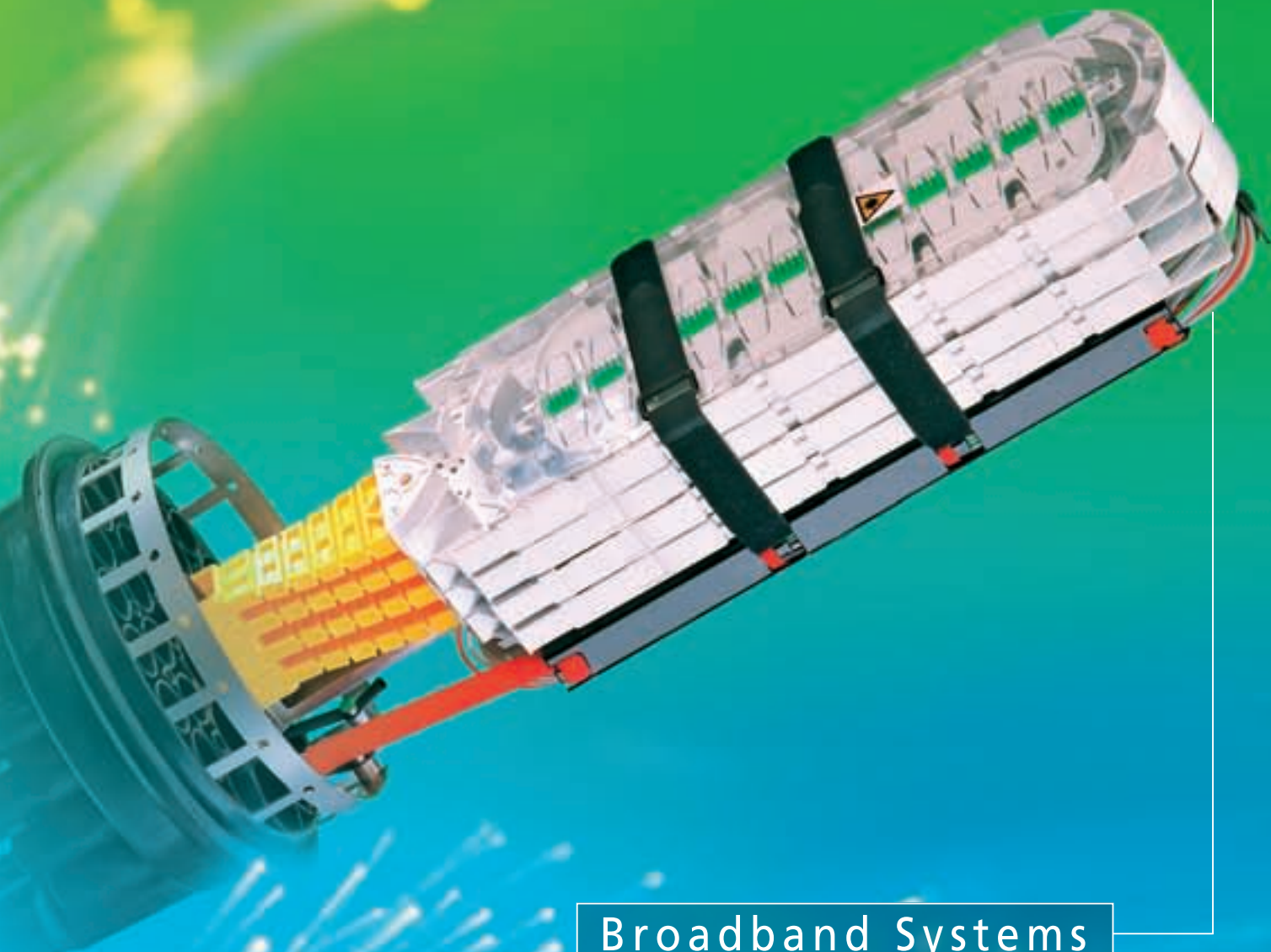

Broadband Systems

Telecom Fibre & Copper Products

HellermannTyton

If you want to offer your customers top-class,
you must never stop looking for improvement

A premium seller with a passion:

At **HellermannTyton** we have a special passion; our self-imposed commitment to innovation for everything to do with cables. Our company philosophy is not only geared towards achieving unique products but also towards offering an outstanding level of service quality, in a tailor-made form that you will find nowhere else.

Innovation through dialogue and research:

No matter how different their requirements may be, there is one thing all our customers have in common: they expect top quality. We establish the conditions for this by constantly exchanging expertise with you. This provides a foundation on which we can design new solution, which we can then implement for you step-by-step in utility-based products. It is an attitude that affects all our development processes.

We always try to be one step ahead of your particular requirements. Our own research and development as well as innovative products that set standards throughout the world, help us to achieve this. So far this principle has led to more than 20,000 products.

Our Success proves right:

HellermannTyton is one of the leading suppliers of products for fixing, fastening, identifying and protecting cables and their connecting components. We also develop pioneering systems in the field of data and network technology.

In our book, standing still means stepping back:

Whether trade or industry – we shall remain your "Number One Address". This is why we not only permanently invest in research and development but are constantly re-examining our entire product range. In doing so, we consider our products from your point of view. The value of this change in perspective is shown by the success that gives us fresh motivation each day. It is the motor that drives us on.



Mission Statement

HellermannTyton's mission is to provide innovative solutions, with customer satisfaction as our first priority.

We aspire, through global leadership and quality products that add value to electrical and communication networks, to be the customers' partner of choice.

We aim to achieve world class operational excellence for the benefit of our customers, our employees and the interaction of our business with the environment.



Design Capabilities

HellermannTyton products division is composed of powerful and efficient development, engineering and testing teams



In-Depth Analysis

HellermannTyton customers can expect an expert appraisal of their requirements which will be met with an innovative and practical solution



Bespoke Service

HellermannTyton will assess and respond to specific customer requirements for a bespoke fully tailored solution. Our engineering and development teams can adapt and implement customised products in a professional manner.

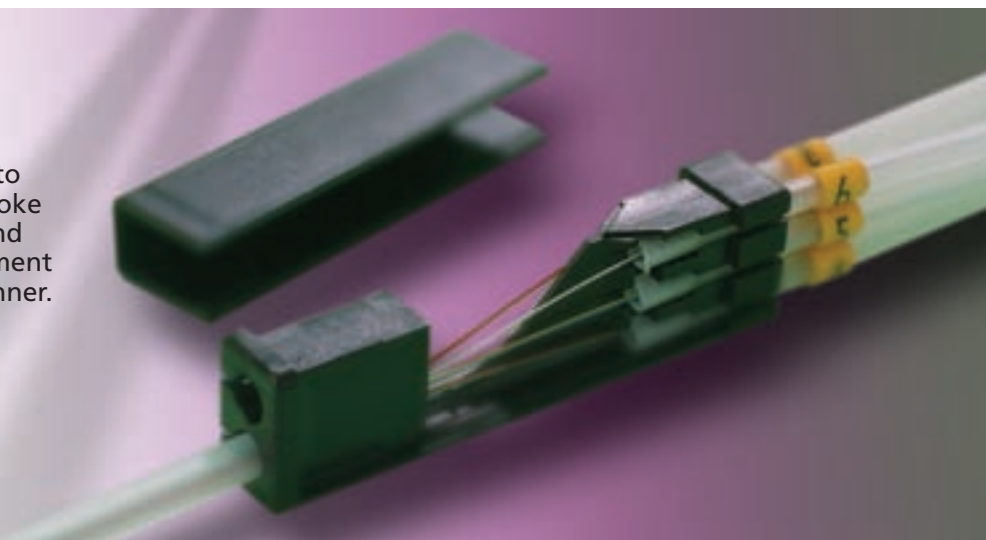



Section 1 Contents & Introduction

Pages

3-4



Section 2 Fibre Optic Products

Pages

5-21



Section 3 Copper Products

Pages

22-27



Section 4 Accessories & Tools

Pages

28-33

At the leading edge of fibre and copper management

The Broadband Systems Division of HellermannTyton has designed a remarkably innovative range of fibre splicing closures for external and internal plant equipment. These sealed closures protect the fibre and copper management systems from adverse environmental conditions whilst maintaining ready access for effective cable installation. Fibres are housed in space-saving modular units that minimise network disruption and have been designed to allow further modules to be added at a later date for increased capacity, thus ensuring a future proof design. Copper closures utilise the same external housings as fibre closures to give familiarity across the product range.

Designing solutions for the future

More and more customers are demanding maximum flexibility and a modular approach to cable management systems that will fit into existing and future networks. All closures have therefore been designed to cater for this requirement and also the wide variety of fibre optic cables that are now available including slotted core, loose tube, compact, ribbon and blown fibre / cable applications. Additionally HellermannTyton are aware of European Standards (CENELEC) and International Standards (IEC). This is reflected in the design, performance and future-proofing of the fibre product range.

The closures have also been designed to meet customer's demands for various fibre management systems including single circuit, single element, multiple element and cross connectivity.

Tray design is evolving to meet the various needs of bend sensitive fibres, for which the **Hellipse™** NZDF range has been developed, increased fibre storage capacity, the ability to change direction of the fibres and to cater for the various types of splice protectors and PON devices that are now available in the global market.

Other products

This catalogue contains details of our core products, however the Broadband Systems design team is able to customise products to exact customer requirements where necessary. Please contact our Sales Office for more details.

Quality

The continuous improvements in design, manufacturing control and product testing have earned HellermannTyton ISO9001 and ISO14001 approval from BSI.

Note: HellermannTyton reserve the right to make changes in materials, design or processing, without notification to the buyer, which do not affect compliance with any applicable specification to maintain improved performance.





	Page
Fibre Optic Splice Trays	6-9
Fibre Optic Internal Wall Boxes	10
Fibre Optic Splice Closures	11-20
Closure Accessories	21

Hellacurve™

- Unique curved design
- Compact size for small low fibre count closure
- Optimum fibre bend diameter of 60mm
- 12 entry ports
- Moulded splice holder fins for standard heatshrink (3A) splice protectors
- Used in the FST closure
- Fibre protection tubes secured with cable ties
- For splice capacity see table on page 9
- Overall dimensions 161mm long, 86mm diameter across and 76mm deep



Hellapon™ - Small

- Universal compact size for small closures
- Optimum fibre bend diameter of 60mm
- 2 entry ports and 2 mounting positions for splice inserts
- Accepts various inserts for heatshrink or mechanical splice protectors
- Inserts can also accept PON devices
- Used in the FST and FRBU closures
- Fibre protection tubes secured with cable ties or rubber retainer blocks (Tubefix)
- Supplied with splice retaining strap
- Tray can be mounted either on a fixed support or flexible end mounted hinge
- Back to back mounting capability for routing fibre between two mating trays
- For splice capacity, see table on page 9
- Overall dimensions 158mm x 85mm x 9mm



Hellapon™ - Medium

- Rectangular tray for single element applications
- Optimum fibre bend diameter of 60mm
- 4 entry ports
- Moulded splice holder fin options for heatshrink (3A) and ANT mechanical splice protectors
- Also available without fins for mounting other holder types or devices
- Style A trays are coloured coded, white (3A), yellow (ANT)
- Used in the FRBU, FML, PLC closures and specialist applications
- Tray style A can mounted either on a fixed support or flexible side hinges
- Tray style B has side mounted pivot points
- Fibre protection tubes secured with cable ties
- Supplied with splice retaining strap
- For splice capacity, see table on page 9
- Overall dimensions 235mm x 96mm x 7mm



Style A (ANT shown)



Style B

Hellafos™

- Circular tray for single element applications
- Optimum fibre bend diameter of 60mm
- 4 and 6 entry ports options
- Moulded splice holder fin options for standard heatshrink (3A)
- For splice capacity, see table on page 9
- Also available without fins for mounting other holder types or devices
- Also available in LFH polymer in black
- Used in wallboxes and specialist applications
- Fibre protection tubes secured with cable ties
- Supplied with splice retaining strap
- Overall dimensions 131mm x 152mm x 10mm

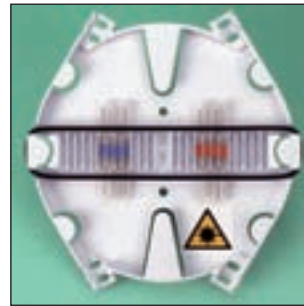

With moulded fins



Without fins

Hellipse™ NZDF SE-A

- Elliptical tray for single element and single circuit applications
- Fibre bend diameter of 75mm for NZDF Cables
- Recommended for up to 1625nm bandwidth
- Bend limiting positive fibre management
- 10 entry ports
- Accepts 2 inserts for heatshrink or mechanical splice protectors (for splice capacity, see table on page 9)
- Inserts can also accept PON devices
- Used in FDN, UFC closures and wallboxes
- Fibre protection tubes secured with cable ties or rubber retainer blocks (Tubefix)
- 2 pivot points for mounting into a 6 tray module
- Back to back mounting capability for routing fibre between two mating trays
- Overall dimensions 202mm x 148mm x 7mm

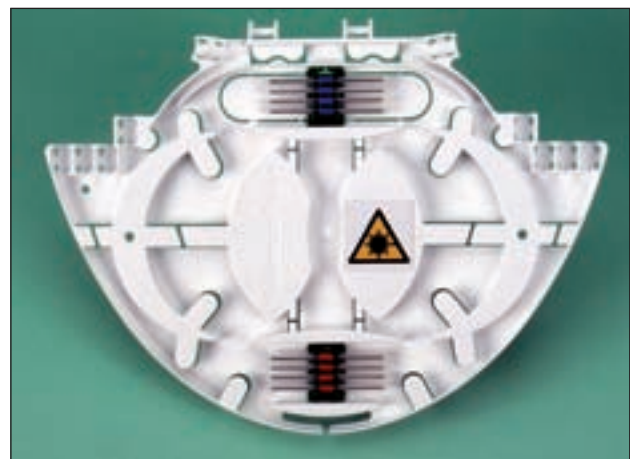

Hellipse™ NZDF SE-B

- Elliptical tray for single element and single circuit applications identical to the SE-A tray but with reduced width
- Fibre bend diameter of 75mm for NZDF Cables
- Recommended for 1625nm bandwidth
- Bend limiting positive fibre management
- 8 entry ports
- Accepts 2 inserts for heatshrink or mechanical splice protectors (for splice capacity, see table on page 9)
- Inserts can also accept PON devices
- Used in FML closure and wallboxes
- Fibre protection tubes secured with cable ties or rubber retainer blocks (Tubefix)
- 2 pivot points for mounting into a 6 tray module
- Back to back mounting capability for routing fibre between two mating trays
- Overall dimensions 184mm x 148mm x 7mm

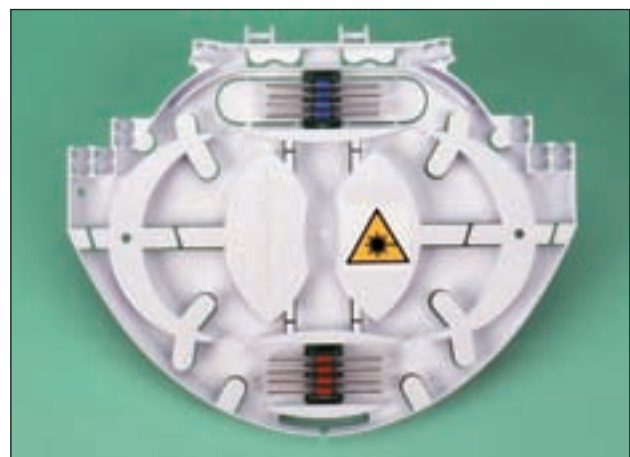

Hellipse™ NZDF SC-1

- Elliptical tray for single circuit applications
- 3.5mm thick tray allows higher closure capacity compared to other Hellipse™ styles. 12 trays fit into a standard 6 tray module
- Fibre bend diameter of 75mm for NZDF Cables
- Recommended for up to 1625nm bandwidth
- Bend limiting positive fibre management
- 6 entry ports
- Accepts 8 heatshrink (3A) or 8 ANT splice protectors (see table on page 9)
- Used in UFC, FML, FDN closures and wallboxes
- Fibre protection tubes secured with integrally moulded retention features
- Ideally suited in last mile FTTX applications for multiple customer closures
- Overall dimensions 184mm x 148mm x 3.5mm



Hellipse™ - SMF

- Elliptical tray for single element applications
- Optimum fibre bend diameter of 60mm
- 12 cable entry ports
- Moulded splice holder fin options for heatshrink (3A)
- For splice capacity, see table on page 9
- Also available without fins for mounting other holder types or devices
- Used in FDN, UFC closures and wallboxes
- Fibre protection tubes secured with cable ties or rubber retainer blocks (Tubefix)
- Has 2 pivot points for mounting into a 6 tray module
- Supplied with splice retaining strap
- Overall dimensions 195mm x 148mm x 7mm



Hellamass™ - Large

- Rectangular double sided tray for high fibre count multiple element and ribbon applications (for ribbon applications consult technical department on +44 (0) 1604 707420)
- Fibre bend diameter of 75mm for NZDF Cables
- 4 wide cable entry ports
- Accepts 24 inserts (12 each side) for heatshrink or mechanical splice protectors (for splice capacity, see table on page 9)
- Inserts can also accept PON devices
- Used in the FML and UFC Closures plus rack mounted applications. Design of tray allows cable entry and exit from the same side as well as fibre route reversal if required
- Storage area on reverse side for excess fibre
- Clear plastic cover plates on both sides
- Single pivot point for mounting onto a flexible hinge
- Fibre protection tubes or cables secured with cable ties
- Removable windows for mounting up to 12 optical connectors
- Overall dimensions 440mm x 145mm x 19mm

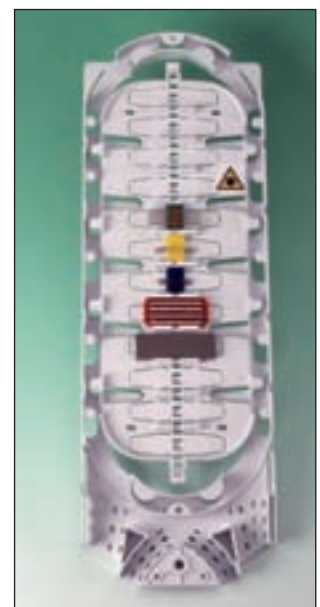

Types of splice protector inserts and maximum splices for trays

Splice Protector Inserts							
Tray Type	HS 3A (large) With Band *	4 Fibre Ribbon	HS 6A (Small)		ANT	3M Fibrelok™	12 Fibre Ribbon
			With Band *	Without Band			
Hellacurve™	24	-	-	-	-	-	-
Hellapon™ - Small	12	32	16	18	24	8	-
Hellapon™ - Medium	16	-	16	-	24	-	-
Hellafos™	24	-	-	-	-	-	-
Hellipse™ NZDF SE-A	12	32	16	18	24	8	48
Hellipse™ NZDF SE-B	12	32	16	18	24	8	48
Hellipse™ SC-1	8	-	-	-	8	-	-
Hellipse™ SMF	24	-	-	-	-	-	-
Hellamass™ Large	144	384	192	216	288	96	576

Moulded Splice Fins

3A/PON Insert

6A Insert

ANT Insert

Ribbon Insert

* Splice protector anti-vibration band

Note: for PON device applications please contact our technical department on +44 (0) 1604 707420

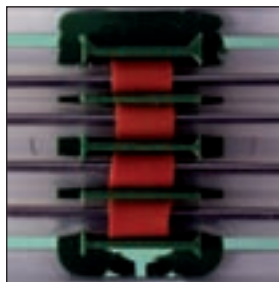

6 Way
3A/PON Insert

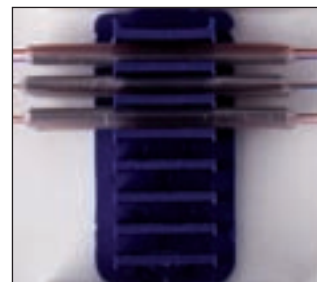

9 Way
6A Insert

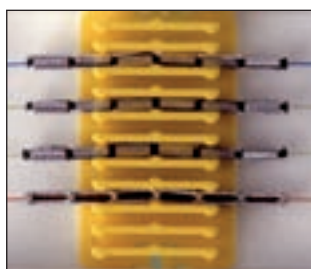

12 Way
ANT Insert



4 Way
Ribbon Insert

CPU - Customer Premise Unit

The CPU is a low cost compact surface mounted optical distribution box used for the organisation and protection of fibre optic splices in internal environments. Manufactured from either epoxy coated steel or plastic, it contains 1 Hellafos™ splice tray mounted on a cable loop storage spool.

- 2 piece box with integral seal
- Robust construction in PVC
- Contains 1 Hellafos™ splice tray for up to 24 3A heatshrink splice protectors (12 splices maximum recommended)
- Compact and low profile
- Multiple cable entries
- Each kit is supplied with cable glands and cable management materials
- Box complies to IP56 seal rate

Typical application

- The jointing of low fibre count distribution cables in internal and sheltered environments
- For additional details and more kits for plastic box applications please contact our sales office

CPU Dimensions (mm)		
Height	Width	Depth
195	145	80



Plastic CPU

CPU Kits			
UNS No.	Reference	No. of Cable Entries	Position and Gland Size
857-00349	CPU3862	2	2 PG16 glands on same side only
857-00350	CPU3863	4	2 PG11 glands on one side and 2 PG16 glands on the opposite
857-00351	CPU3864	4	2 PG9 glands on one side and 2 PG16 glands on the opposite
857-00352	CPU3865	2	1 PG16 gland on one side and 1 PG9 for 4x Pigtails on the opposite

BFP - Building Flexibility Point

The BFP is a 48 fibre capacity wall mounted box used for the organisation and protection of fibre optic cable splices. The main application is in internal environments such as office complexes where an external cable is to be joined to internal cables using fibre optic splices. Manufactured from epoxy coated steel, the box contains 4 Hellafos™ splice trays mounted on a hinged plate for access to a fibre storage basket.

- Aesthetic design with rounded edges
- Robust construction in rust proofed steel
- Contains 4 Hellafos™ splice tray for up to 96 3A heatshrink splice protectors (48 splices maximum recommended)
- Single hinged door fitted with 2 quarter turn chrome plated key locks
- Integral back plate with cable strength member anchor points
- Fibre storage area behind hinged splice tray mounting plate
- Cable entries at top and bottom
- Range of bulkhead gland plates available for various cable entries
- Supplied with cable management materials

Typical Applications

The splicing and distribution of external cables to internal cables within buildings without the use of connectors thereby reducing optical losses and cost of installation.

Note: Glands and bulkhead plates for cable entry must be ordered separately to suit application.

Note: Customised wallboxes can be ordered to meet -specific requirements. Please contact our sales office for further information.



BFP1019C

BFP Dimensions (mm)		
Height	Width	Depth
350	350	128

BFP - Building Flexibility Point			
UNS No.	Reference	Cable Entries and Gland Type	Number of Trays
857-00009	BFP1019C	See table below	4

BFP Bulkhead Plate Selection Chart		
UNS No.	Reference	Gland type and Number Kit
857-00012	BFP1022C	Blank plate
857-00013	BFP1024	2 PG16 glands and 2 PG16 blanking plugs
857-00017	BFP1840	2 PG21 glands and 2 PG21 blanking plugs
857-00018	BFP3643	2 M25 glands and 2 M25 blanking plugs

FST - Fibre Small Tray

The FST is a compact cap-ended ready access closure used for the organisation and protection of fibre optic cable splices in aerial, underground and directly buried installations.

It is available with 3 base configurations having 3, 10 or 12 round cable ports and an oval port for loop through applications. The closure cover is environmentally sealed to the base using a rolling "O" ring whilst the cables are sealed using either heatshrink sleeving or Cablelok™ non-heatshrink seals (see page 32) depending on the base configuration selected.

Each base configuration can be supplied with a single Hellacurve™ curved tray or multiple Hellapon™ - Small trays.

Hellapon™ - Small tray versions can be supplied with up to 3 Hellapon™ - Small trays. 2 trays are mounted back to back, the 3rd tray is mounted on a flexible hinge for easy access. FST's may also be supplied with 1 fixed Hellapon™ - Small Tray and a fibre storage basket for loop through applications.

- Maximum 36 fibre capacity using standard heatshrink splice protectors
- Small trays giving compact size closures
- Mounting plate for connectorised cables and pigtails (FC/PC & ST) on the Hellacurve™ tray
- Base to cover clamp with quick release Snapperband™ or stainless steel latch clamp
- Cablelok™ FST's can be supplied with a variety of Cablelok™ sizes to suit the base configuration (see page 32 for cable range)
- Heatshrink kits are supplied with 1 sleeve and branch clip for the oval port and 2 sleeves for the B ports
- Supplied with cable surface preparation, management and identification materials
- Other options and spur cable sealing kits available, please contact our sales office

Typical Applications

FST with the Hellacurve™ Tray

- Splicing low fibre count cables in CCTV, trunk and campus (between buildings) networks

FST with the Hellapon™ - Small Tray

- Splicing low fibre count distribution cables in fibre to the home (FTTH), fibre to the kerb (FTTK) and CATV

Accessories

- Port opening tools TPC1940, TPC1941, TPC1942 and TPC3337 (see page 35)
- Pole or wall mounting bracket kit ACC1037 (see page 13)
- Cover release tool TCR1726 (see page 35)



4 Way Hellacurve™ Pigtail Connector Plate (FC/PC or ST)

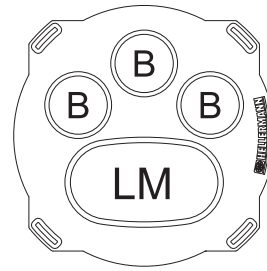

4 port Base
(Heatshrink & Cablelok™)

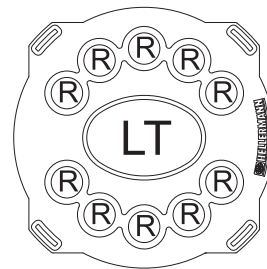

11 Port Base
(Heatshrink & Cablelok™)

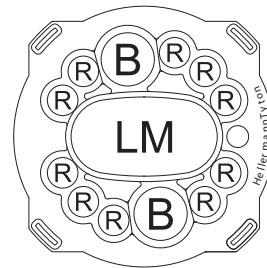

13 Port Base
(Cablelok™ only)



FST with 4 port base & Hellacurve™ tray



FST with 13 port base, Hellapon™ - Small Tray & storage basket

FST Dimensions (mm)	
Length	Diameter
310	110

Port	No. of Ports	Cable Range (mm)	
		Cablelok™	Heatshrink
LM	1	2 x 9.5 - 22.0	2 x 8.0 - 22.0
LT	1	Not applicable	2 x 8.0 - 15.0
B	2 or 3	4.8 - 16.5	6.0 - 19.0
R	10	1.7 - 9.5	Not applicable

FST Kits					
UNS No.	Reference	No. of Ports	No. of Trays	Type of Tray	Method of Sealing
857-00166	FST1754	4	1	Hellacurve™	Cablelok™
857-00169	FST1845	4	1	Hellacurve™	Cablelok™ & Heatshrink**
857-00168	FST1844	11	1	Hellacurve™	Cablelok™
857-00179	FST3577	13	2	Hellapon™ - Small	Cablelok™
857-00180	FST3578	13	3	Hellapon™ - Small	Cablelok™
857-00181	FST3697	4	2	Hellapon™ - Small	Cablelok™
857-00182	FST3705	4	2	Hellapon™ - Small	Heatshrink
857-00195	FST3803*	11	1	Hellapon™ - Small	Cablelok™ & Heatshrink**
857-00196	FST3804*	13	1	Hellapon™ - Small	Cablelok™

* Closure is fitted with fibre loop storage basket

** Includes heatshrink for LT oval port

FRBU - Fibre Residential and Business Unit

The FRBU is a cap-ended ready access closure of compact size used for the organisation and protection of fibre optic cable splices in aerial, underground and direct buried installations.

It is available with 2 base configurations having 8 or 10 round cable ports and an oval port for loop through applications. The closure cover is fitted with a pressure release valve and is environmentally sealed to the base using a rolling "O" ring. Cables are sealed using either heatshrink sleeving or Cablelok™ non-heatshrink seals (see page 32).

The FRBU can be supplied with 2 tray options. 2 to 6 Hellapon™ - Medium trays are mounted on a central rigid support. The trays can be stacked (short cover) or with 2 side hinges (long cover). Alternatively 6 Hellapon™ - Small trays mounted on flexible end hinges (short cover) are available.

- Maximum 96 fibre (72 fibre recommended) capacity using standard heatshrink splice protectors
- Approvals from PTT's worldwide
- Hellapon™ - Medium trays have integral splice fins
- Hellapon™ - Small trays giving compact size closures with interchangeable inserts for various types of splices (see page 9)
- Base to cover clamp with quick release Snapperband™ or stainless steel latch clamp
- The heatshrink kits are supplied with 1 sleeve and branch clip for the oval port and 2 sleeves for the round ports
- Cablelok™ kits are supplied with 1 off each R1, R2, R3 and 2 off B2 Cableloks™. 9 port Hellapon™ - Medium tray kits also have 1 off L1 Cablelok™
- The kits are also supplied with cable surface preparation, management and identification materials
- For kit options not listed or spur cable sealing kits, please contact our Sales Office

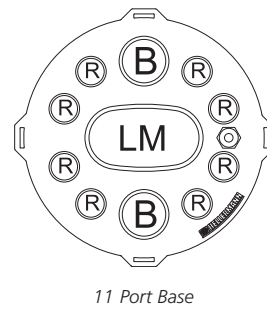
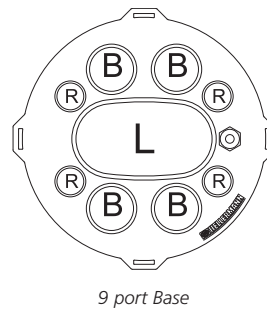

Hinged FRBU with Hellapon™ - Medium trays



Stacked FRBU with Hellapon™ - Medium trays



FRBU Dimensions (mm)

Type	Length	Diameter
Hellapon™ - Medium Side Hinged	505	130
Hellapon™ - Medium Stacked	435	130
Hellapon™ - Small Flexible Hinged	435	130

FRBU Port & Cable Details

Port	No. of Ports	Cable Range (mm)	
		Cablelok™	Heatshrink
L	1	2 x 13.0 - 22.0	2 x 12.0 - 24.0
LM	1	2 x 9.5 - 22.0	2 x 8.0 - 22.0
B	2 or 4	4.8 - 16.5	6.0 - 19.0
R	4 or 8	1.7 - 9.5	4.0 - 11.0

Typical Applications

Hinged FRBU with Hellapon™ - Medium Tray

- Splicing low to medium fibre count distribution cables in trunk, fibre to the kerb (FTTK) and CATV networks

Stacked FRBU with Hellapon™ - Medium Tray

- For network maintenance and repair
- CCTV installations - multiple cable entries and drops

FRBU with Hellapon™ - Small Tray

- Splicing medium fibre count cables in trunk networks

Accessories

- Port opening tools TPC1939, TPC1940 and TPC3337 (see page 35)
- Pole or wall mounting bracket kit ACC1037 (see below)
- Cover release tool TCR1726 (see page 35)
- Additional Hellapon™ - Medium Tray kit ACC1341 (UNS 857-40003)



FRBU with Hellapon™ - Medium trays and loop storage basket

Hinged FRBU with Hellapon™ - Medium Trays					
UNS No.	Reference	No. of Ports	No. of Trays	Type of Tray	Method of Sealing
857-00138	FRBU2565	9	6	Hellapon™ - Medium	Cablelok™
857-00132	FRBU2372	9	6	Hellapon™ - Medium	Heatshrink
857-00164	FRBU3771*	9	3	Hellapon™ - Medium	Cablelok™
857-00165	FRBU3772*	9	3	Hellapon™ - Medium	Heatshrink

*Closure is fitted with fibre loop storage basket

Stacked FRBU with Hellapon™ - Medium Trays					
UNS No.	Reference	No. of Ports	No. of Trays	Type of Tray	Method of Sealing
857-00103	FRBU1313	9	2	Hellapon™ - Medium	Heatshrink
857-00104	FRBU1314	9	4	Hellapon™ - Medium	Heatshrink
857-00105	FRBU1315	9	6	Hellapon™ - Medium	Heatshrink
857-00113	FRBU1323	9	2	Hellapon™ - Medium	Cablelok™
857-00114	FRBU1324	9	4	Hellapon™ - Medium	Cablelok™
857-00115	FRBU1325	9	6	Hellapon™ - Medium	Cablelok™
857-00100	FRBU1310	11	2	Hellapon™ - Medium	Heatshrink
857-00101	FRBU1311	11	4	Hellapon™ - Medium	Heatshrink
857-00102	FRBU1312	11	6	Hellapon™ - Medium	Heatshrink
857-00110	FRBU1320	11	2	Hellapon™ - Medium	Cablelok™
857-00111	FRBU1321	11	4	Hellapon™ - Medium	Cablelok™
857-00112	FRBU1322	11	6	Hellapon™ - Medium	Cablelok™



FRBU with Hellapon™ - Small trays

FRBU with Hellapon™ - Small Trays					
UNS No.	Reference	No. of Ports	No. of Trays	Type of Tray	Method of Sealing
857-00155	FRBU3579	9	6	Hellapon™ - Small	Cablelok™
857-00156	FRBU3580	9	6	Hellapon™ - Small	Heatshrink



FRBU/FST Mounting Bracket ACC1037 (UNS 857-40000)

FDN – Fibre Distribution Node

The FDN is a medium size oval shaped cap-ended ready access closure. Primarily used in FTTH networks for the organisation, protection and distribution of fibre optic cable splices in aerial, underground and directly buried installations.

It is available with a single base configuration having 58 round cable ports and an oval port for loop through applications.

The closure cover which is fitted with a pressure relief valve is environmentally sealed to the base using an “O” ring and quick release clamp. The cables are sealed using either heatshrink sleeving (with the exception of the R ports) or Cablelok™ non-heatshrink seals on all ports.

The FDN is supplied with either 12 Hellipse™ SE-A trays, 24 Hellipse™ SC-1 trays or 12 Hellipse™ SMF trays in two tray retaining modules mounted on a fixed support.

- Maximum 144 fibre capacity using standard heatshrink splice protectors
- Hellipse™ SE-A trays have interchangeable snap-in inserts for various types of splices (see page 9)
- Hellipse™ SMF trays have moulded fins (see page 9)
- Quick release base to cover clamp
- Cablelok™ only kits contain 2 off each of R1, R2, R3, B1 and S2 Cableloks™
- Cablelok™ and heatshrink kits contain 2 off each R1, R2 and R3 Cableloks™ Plus 4 off heatshrink sleeves for the round ports and the oval port
- The kits are also supplied with cable preparation and identification materials
- For kit options not listed or spur cable sealing kits, please contact our Sales Office

Typical Applications

- Fibre to the home (FTTH) with multiple cable entries for customer connections
- Installation in narrow foot way boxes where space is limited
- Blown fibre/cable installations
- For ribbon or Hellipse NZDF SC-1 single circuit applications please contact our sales office

Accessories

- Port opening tools TPC1941, TPC1942, TPC1943 and TPC3337 (see page 35)
- Wall mounting bracket FDNA3763 (UNS 857-40078)
- Stainless steel wall mounting strap kit ACC3334 (UNS 857-40042)
- FDN installation clamp FDNA3717 (see page 34)
- Loop through basket kit FDNA3764 (UNS 857-40079)



Blown cable FTTH application

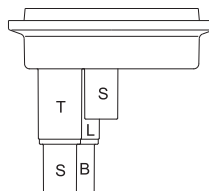
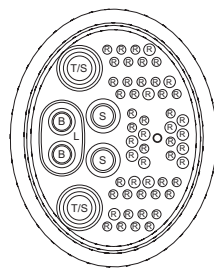

FDN with Hellipse™ NZDF SE-A trays



FDN base configuration



FDN with fibre storage basket



Wall Mounting Bracket

FDN Dimensions (mm)	
Length	Width
455	312/222

FDN Port & Cable Details			
Port	No. of Ports	Cable Range (mm)	
		Cablelok™	Heatshrink
L	1	2 x 13.0 - 22.0	2 x 12.0 - 24.0
T	2	15.5 - 29.0	12.0 - 35.0
S	4	5.0 - 20	12.0 - 26.0
B	2	4.8 - 16.5	6.0 - 19.0
R	52	1.7 - 9.5	-

FDN Kits				
UNS No.	Reference	No. of Trays	Type of Tray	Method of Sealing
857-00042	FDN3583	12	Hellipse™ NZDF SE-A	Cablelok™
857-00043	FDN3584	12	Hellipse™ NZDF SE-A	Cablelok™ & Heatshrink
857-00044	FDN3585	12	Hellipse™ SMF	Cablelok™
857-00045	FDN3586	12	Hellipse™ SMF	Cablelok™ & Heatshrink

PLC - Power Line Closure

The PLC is a stainless steel closure used for the organisation and protection of fibre optic cable splices principally in aerial installations on power line pylons. The PLC is supplied with 8 Hellapon™ - Medium trays pivoted on angled supports

The 2 halves of the stainless steel closure are sealed with a high performance gasket and clamping screws whilst polymeric insulated cables are sealed with either Cablelok™ non-heatshrink seals or heatshrink sleeving. OPGW cables are anchored and sealed to the PLC casing with dedicated stainless steel clamp glands.

- Maximum 128 fibre (96 fibre recommended) capacity using standard heatshrink splice protectors
- Manufactured from 1.2mm thick high grade stainless steel
- Suitable for use with OPGW, ADSS and Wrap cables
- Supplied with either 2, 3 or 4 holes at one end for the mounting of cable glands
- Customised cable entry positions available on request for inline applications
- Shotgun proof
- Integral mounting brackets
- Gland kits for ADSS and Wrap cables contain both heatshrink and non-heatshrink Cablelok™ seals
- Blanking plugs are available for unused gland holes
- Supplied with cable surface preparation, management and identification materials

Typical Applications

- The jointing of fibre optic cables on trunk routes carried on overhead power lines
- Low fire hazard installations such as railway tunnels
- Harsh environments

Accessories

- Tower mounting bracket kit PLCA1721 (UNS 857-40161)
- Lockable security frame kit PLCA3762 (UNS 857-40169)

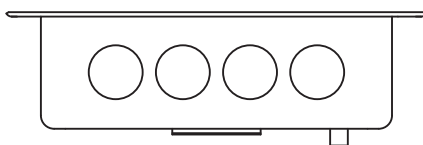

Maximum of 4 holes 31mm dia. for cable glands or blanking plugs

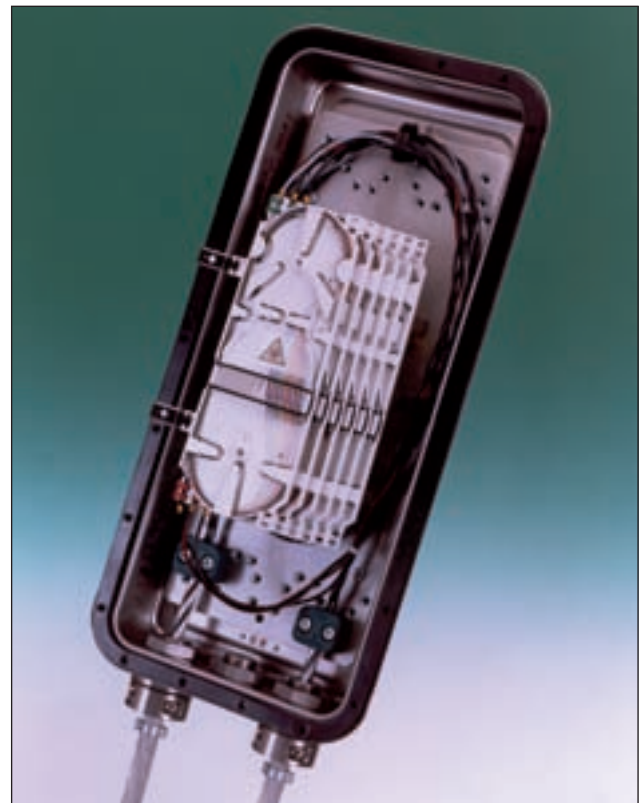

PLC with 8 Hellapon™ - medium trays



PLC sealing glands - available seperately (see below)

PLC Dimensions (mm)		
Length	Width	Depth
515	240	135

PLC Kits			
UNS No.	Reference	Number of Cable Entries	Number of Trays
857-00221	PLC3367	2	8
857-00222	PLC3368	3	8
857-00223	PLC3369	4	8

Gland Kits for ADSS & Wrap Cable			
UNS No.	Reference	Cable Range (mm)	Cablelok™ Seals Supplied
857-40162	PLCA2096	5.2 - 9.5	1 off each R2 and R3
857-40163	PLCA2097	8.0 - 16.5	1 off each B2 and B3
857-40164	PLCA2098	12.0 - 20.0	1 off each S2 and S3

Gland Kits for OPGW Cable		
UNS No.	Reference	Cable Diameter (mm)
857-40157	PLCA1637	12.7
857-40158	PLCA1638	14.1
857-40168	PLCA2326	14.5
857-40159	PLCA1639	16.1
857-40160	PLCA1640	18.8
857-40165	PLCA2099	20.0
857-40166	PLCA2100	25.4
857-40167	PLCA2197	Blanking Plug

Note: The PLC closure is supplied without any sealing glands, which must be ordered separately

Note: Glands for other sizes of OPGW cable can be designed to customer requirements

FML - Fibre Modular Link

The FML is a medium to large cap ended ready access closure used for the organisation and protection of fibre optic cable splices in aerial, underground and direct buried installations. The base configuration features 12 round ports and an oval port for loop through applications. The cover, which is fitted with a pressure test valve, is available in 4 different lengths depending on the number and type of tray selected. The cover is environmentally sealed to the base using an "O" ring and base to cover clamp whilst the cables are sealed using either heatshrink sleeving or Cablelok™ non-heatshrink seals. The FML can be supplied with the following tray options:

- 6, 12, 18 or 24 Hellipse™ NZDF SE-B trays
- 12 Hellapon™ - Medium trays
- 12, 24, 36, or 48 Hellipse™ NZDF SC-1 trays
- 2 Hellamass™ - Large trays

Choice of tray will depend on capacity, whether or not interchangeable splice inserts are required, number of tray entries and type of cable and fibre selected.

- Maximum 288 fibre capacity using standard heatshrink splice protectors
- Quick release base to cover clamp
- The kits with heatshrink sealing materials are supplied with 2 sleeves for the B ports, 1 sleeve for the S or T ports and 1 sleeve and branch clip for the oval port
- If Cablelok™ seals are required as an alternative to heatshrink sleeving, these must be ordered separately (see page 32 for details)
- Supplied with cable surface preparation, management and identification materials
- For additional spur cable sealing kits, please contact our Sales Office



FML base configuration



Strength member anchor plates

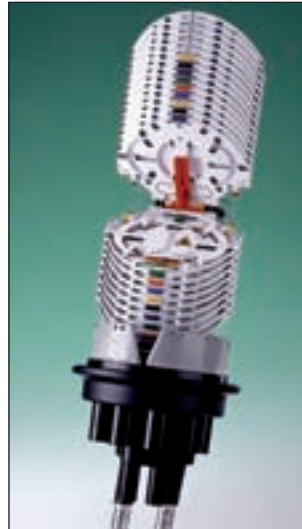

FML with Hellipse™ - NZDF SE-B trays



FML with Hellapon™ - medium trays



FML with Hellamass™ - large trays



FML showing Hellapon™ - medium tray storage basket

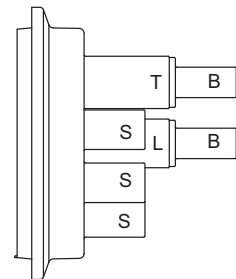
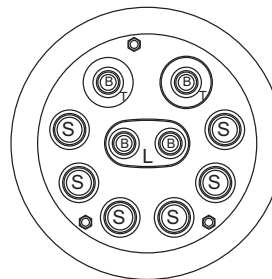

FML Port & Cable Details			
Port	No. of Ports	Cable Range (mm)	
		Cablelok™	Heatshrink
L	1	2 x 13.0 - 22.0	2 x 12.0 - 24.0
T	2	15.5 - 29.0	12.0 - 35.0
S	6	5.0 - 20.0	12.0 - 26.0
B	4	4.8 - 16.5	6.0 - 19.0

FML with Hellipse™ NZDF SE-B and NZDF SC-1 Trays

Splicing in primary rings in metropolitan area networks for both single element and single circuit. For Hellipse NZDF SC-1 single circuit applications please contact our sales office.

FML with Hellapon™ - Medium Trays

Splicing multiple elements in long distance trunk networks with loop storage option

FML with Hellamass™- Large Trays

Splicing high fibre count ribbon cables in super highway primary rings within metropolitan area networks.

Note: For ribbon applications please contact the technical department on +44 (0) 1604 707420.

Accessories

- Port opening tools TPC1942, TPC1943 and TPC3337 (see page 35)
- Wall mounting bracket FMLA3279 (UNS 857-40106)
- Stainless steel wall mounting strap kit ACC3334 (UNS 857-40042)
- Installation clamp for FML UFCA2685 (see page 34)

FML Dimensions (mm)

Cover Reference	Closure Width	Closure Length
A	D1 = 220 D2 = 275	400
B	D1 = 220 D2 = 275	600
BC	D1 = 220 D2 = 275	670
C	D1 = 220 D2 = 275	750

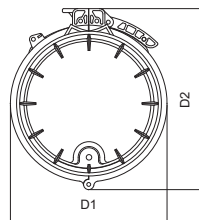

FML Hellipse™ - NZDF SE-B Trays

UNS No.	Reference	No. of Trays	Type of Tray	Method of Sealing	Cover
857-00067	FML3079	6	Hellipse™ NZDF SE-B	Cablelok™*	A
857-00068	FML3080	12	Hellipse™ NZDF SE-B	Cablelok™*	B
857-00069	FML3081	18	Hellipse™ NZDF SE-B	Cablelok™*	B
857-00070	FML3082	24	Hellipse™ NZDF SE-B	Cablelok™*	B
857-00061	FML3073	6	Hellipse™ NZDF SE-B	Heatshrink	A
857-00062	FML3074	12	Hellipse™ NZDF SE-B	Heatshrink	B
857-00063	FML3075	18	Hellipse™ NZDF SE-B	Heatshrink	B
857-00064	FML3076	24	Hellipse™ NZDF SE-B	Heatshrink	B

FML Hellapon™ - Medium Trays

UNS No.	Reference	No. of Trays	Type of Tray	Method of Sealing	Cover
857-00055	FML3005	12	Hellapon™ - Medium	Cablelok™*	B
857-00054	FML3004	12	Hellapon™ - Medium	Heatshrink	B

FML Hellamass™ - Large Trays

UNS No.	Reference	No. of Trays	Type of Tray	Method of Sealing	Cover
857-00092	FML3775	2	Hellamass™ - Large	Cablelok™*	C
857-00093	FML3777	2	Hellamass™ - Large	Heatshrink	C

* Cablelok™ seals for these kits have to be purchased separately

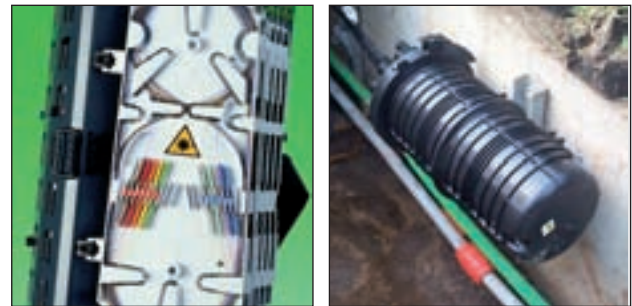

Wall mounting bracket



Range of cover sizes

UFC – Universal Fibre Closure

The UFC is a high fibre capacity cap ended ready access closure used for the organisation and protection of fibre optic cable splices in aerial, underground and direct buried installations. It is available with a single base configuration having 28 round ports and 2 oval ports for loop through applications. The cover is fitted with a pressure test valve and is available in 4 different lengths depending on the number and type of tray selected. The cover is environmentally sealed to the base using an "O" ring and base to cover clamp whilst the cables are sealed using either heatshrink sleeving or Cablelok™ non-heatshrink seals.

The UFC can be supplied with the following tray options:

- 6, 12, 18, 24 or 36 Hellipse™ NZDF SE-A trays
- 6, 12, 18, 24 or 36 Hellipse™ SMF trays
- 12, 24, 36, 48 or 72 Hellipse™ NZDF SC-1 trays
- 4 Hellamass™ - Large trays (other quantities available upon request)

The choice of tray will depend on capacity, whether or not interchangeable splice inserts are required, number of tray entries and type of cable and fibre selected.

- Maximum 384 fibre capacity using standard heatshrink splice protectors (NZDF SE-A trays)
- Quick release base to cover clamp
- Kits with heatshrink sealing materials are supplied with 2 sleeves for the B ports, 1 sleeve for the S or T ports and 1 sleeve and branch clip for the oval ports
- If Cablelok™ seals are required as alternative to heatshrink sleeving, these must be ordered separately (see page 32 for details)
- All Hellipse™ tray UFC's are fitted with loop storage baskets
- Supplied with cable surface preparation, management and identification materials
- For additional spur kits, please contact our Sales Office

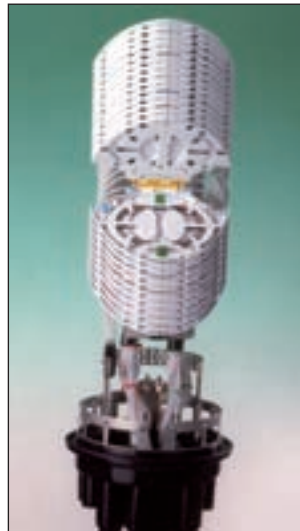

UFC with Hellipse™ NZDF SE-A trays



UFC with Hellipse™ SMF trays



UFC with Hellamass™ large trays and storage basket

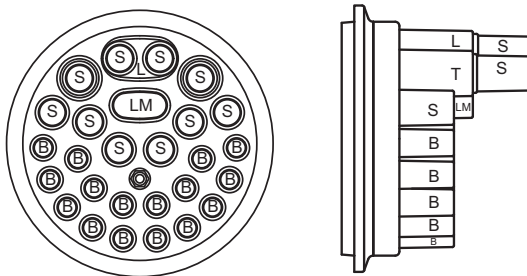

UFC Port & Cable Details			
Port	No. of Ports	Cable Range (mm)	
		Cablelok™	Heatshrink
L	1	2 x 13.0 - 22.0	2 x 12.0 - 24.0
LM	1	2 x 9.5 - 22.0	2 x 8.0 - 22.0
T	2	15.5 - 29.0	12.0 - 35.0
S	10	5.0 - 20.0	12.0 - 26.0
B	16	4.8 - 16.5	6.0 - 19.0



UFC base configuration

UFC with Hellipse™ NZDF SE-A, NZDF SC-1 and SMF Trays

Splicing in primary rings in metropolitan area networks for both single circuit and single element. For Hellipse NZDF SC-1, single circuit applications please contact our sales office.

UFC with Hellamass™ - Large Trays

Splicing high fibre count ribbon cables in super highway primary rings within metropolitan area networks

Accessories

- Port opening tools TPC1942, TPC1943 and TPC3337 (page 35)
- Wall mounting bracket UFCA2564 (UNS 857-40180)
- Stainless steel wall mounting strap Kit ACC3334 (UNS 857-40042)
- UFC Installation clamp UFCA2685 (see page 34)

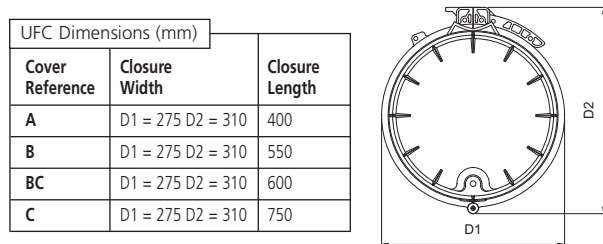

UFC with Hellipse™ - NZDF SE-A Trays

UNS No.	Reference	No. of Trays	Type of Tray	Method of Sealing	Cover
857-00252	UFC2794	6	Hellipse™ - NZDF SE-A	Cablelok™	A
857-00269	UFC2868	12	Hellipse™ - NZDF SE-A	Cablelok™	BC
857-00270	UFC2869	18	Hellipse™ - NZDF SE-A	Cablelok™	C
857-00271	UFC2870	24	Hellipse™ - NZDF SE-A	Cablelok™	C
857-00272	UFC2871	30	Hellipse™ - NZDF SE-A	Cablelok™	C
857-00273	UFC2872	36	Hellipse™ - NZDF SE-A	Cablelok™	C
857-00247	UFC2770	6	Hellipse™ - NZDF SE-A	Heatshrink	A
857-00264	UFC2844	12	Hellipse™ - NZDF SE-A	Heatshrink	BC
857-00265	UFC2845	18	Hellipse™ - NZDF SE-A	Heatshrink	C
857-00266	UFC2846	24	Hellipse™ - NZDF SE-A	Heatshrink	C
857-00267	UFC2847	30	Hellipse™ - NZDF SE-A	Heatshrink	C
857-00268	UFC2848	36	Hellipse™ - NZDF SE-A	Heatshrink	C

UFC with Hellamass™ - Large Trays

UNS No.	Reference	No. of Trays	Type of Tray	Method of Sealing	Cover
857-00316	UFC3779	4	Hellamass™ - Large	Cablelok™	C
857-00317	UFC3780**	4	Hellamass™ - Large	Cablelok™	C
857-00318	UFC3781	4	Hellamass™ - Large	Heatshrink	C
857-00319	UFC3782**	4	Hellamass™ - Large	Heatshrink	C

*Cablelok™ seals for these kits have to be purchased separately

**Hellamass™ UFC fitted with fibre loop storage basket

UFC with Hellipse™ - SMF Trays

UNS No.	Reference	No. of Trays	Type of Tray	Method of Sealing	Cover
857-00328	UFC2837	6	Hellipse™ SMF	Cablelok™	BC
857-00329	UFC2838	12	Hellipse™ SMF	Cablelok™	BC
857-00262	UFC2839	18	Hellipse™ SMF	Cablelok™	C
857-00330	UFC2840	24	Hellipse™ SMF	Cablelok™	C
857-00331	UFC2841	30	Hellipse™ SMF	Cablelok™	C
857-00332	UFC2842	36	Hellipse™ SMF	Cablelok™	C
857-00333	UFC2831	6	Hellipse™ SMF	Heatshrink	BC
857-00260	UFC2832	12	Hellipse™ SMF	Heatshrink	BC
857-00334	UFC2833	18	Hellipse™ SMF	Heatshrink	C
857-00261	UFC2834	24	Hellipse™ SMF	Heatshrink	C
857-00335	UFC2835	30	Hellipse™ SMF	Heatshrink	C
857-00336	UFC2836	36	Hellipse™ SMF	Heatshrink	C



Wall mounting bracket



Range of cover sizes

BFJ - Blown Fibre Joint

The BFJ is a ready access pan type closure for use as a straight through joint, a customer drop point or a centre blow point for blown fibre underground networks. The closure consists of a circular body with 4 sets of 3 sealed inlets at right angles to each other around its circumference. The closure can be supplied with an integral moulded base and separate cover that is sealed to the body using an "O" ring and stainless clamp (BFJ2244) or with a separate base and cover both of which are sealed to the body by "O" rings and clamps (BFJ2131). An expansion kit (BFJA2312) consisting of the body, "O" ring and clamp is also available so that bodies can be stacked and sealed to each other if cable duct tube entry points in manholes are at different levels.

The BFJ kits are supplied with 4 yellow tube holders which are mounted around the inside of the closure and used for the routing of 5mm diameter blown fibre mini-duct tubes or cable. The outer jacket of the mini-duct tube bundles or cables are sealed into the entry ports using either 'B' or 'S' series Cablelok™ non-heatshrink seals or heatshrink sleeving. The maximum diameter of duct or cable that the ports can accept being 50mm with heatshrink and 20.0mm with Cablelok™ (see page 32 for details).

- Modular design that can be expanded in the field
- Multi-port base configuration
- Cover supplied with 5 psi (35 Kpa) pressure relief valve
- Large internal bend diameter (300mm) for long distance blowing of fibres
- Duct and cable sealing with either Cablelok™ or heatshrink sleeving
- All closure kits are supplied with stainless steel clamps, "O" rings and 4 pre-fitted duct tube organisers

Typical Applications

- Trunk routes
- Metropolitan networks (MAN)
- Wide area networks (WAN)
- Fibre to the home (FTTH)

Accessories

- Single heatshrink sleeve kit plus preparation materials BFJ2133 (UNS 857-00002)
- Closure expansion kit (closure body, clamp and seal) BFJA2312 (UNS 857-40064)

BFJ Closure Kits		
UNS No.	Reference	Description
857-00000	BFJ2131	Closure body with top and bottom covers
857-00006	BFJ2244	Closure body with integral base and top cover*

Note: Cablelok™ non-heatshrink seals can be purchased separately (see page 32 for details).



BFJ2244



Internal view of BFJ2244



BFJ Dimensions (mm)			
D1	D2	Internal Diameter	Height
335	424	300	238

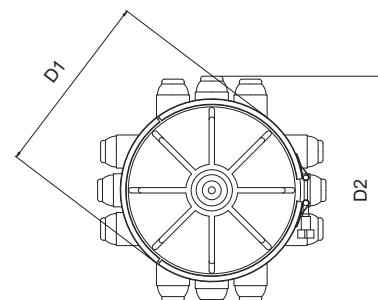

Manifolds

A fibre manifold is a device for dividing and managing fibres within a splice closure or an optical distribution frame. It consists of a moulded divider with snap on cover with 1 or 2 polyethylene tubes inserted at one end and a number of similar tubes at the other. The input tubes are simply fitted over a fibre cable element or loose tube and the group of fibres is then divided into the required number per output tube for routing to the splice area.

- Snap fit construction
- Small and compact
- Removable tubes
- Supplied with identification sleeves
- Suitable for most types of cable construction

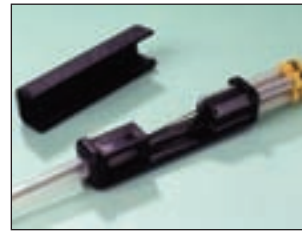

4 way manifold

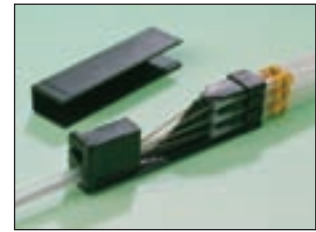

6 way manifold

Manifolds		Inlet tubes			Outlet Tubes			Manifold Dimensions	
UNS No.	Reference	No. of Inlets	Bore Dia (mm)	Length (mm)	No. of Outlets	Bore Dia. (mm)	Length (mm)	WxH (mm)	Length (mm)
857-40085	FM2036	1	4	75	4	3	1000	9.0x9.0	35.5
857-40086	FM2092	1	4	1000	4	3	1500	9.0x9.0	35.5
857-40088	FM2465	2	4	1000	6	3	1500	9.0x14.0	55
857-40105	FM3747	2	3	1000	6	3	1500	9.0x14.0	55

Adapters

The application of an adapter is similar to a manifold except that it is fitted directly over the cable sheath (upto 15mm outside diameter) with the unit tubes or groups of fibres being fed through flexible tubing or wrapped with spiral cut tubing for loop through applications. All kits are supplied with both types of tubing, cable ties and markers apart from FM3620 which contains no spiral cut tubing.



6, 12, 24 way adapters

Adapters			
UNS No.	Reference	No. of Outlets	Bore Dia (mm)
857-40101	FM3620	6	4.0
857-40102	FM3621	12	3.0
857-40103	FM3622	24	3.0

Splice Protectors

Fibre splice protectors consist of a heatshrinkable sleeve containing an inner liner of hot meltable adhesive and a stainless steel re-inforcing rod. Specifically designed for the mechanical and environmental protection of fused fibre optic cable splices.

- Available in lengths of 25, 35, 45 and 60mm
- Supplied in either 3A or 6A sizes
- Available in 12 colours and natural transparent
- 3A size fitted with a rubber sleeve for dampening of vibration
- Available for up to 12 fibre ribbon cable incorporating a ceramic re-inforcing member

Splice Protectors					
UNS No.	Reference	Pack Qty.	Type	Length (mm)	Colours
857-40120	FSP650	80	3A	35	Natural
857-40127	FSP738	80	3A	45	Natural
857-40129	FSP758	80	3A	45	10 Colours
857-40112	FSP1242	100	3A	60	Natural
857-40114	FSP1279	80	3A	60	8 Colours
857-40118	FSP3563	80	6A	25	Natural
857-40119	FSP3564	80	6A	40	Natural
857-40130	FSP770	100	Ribbon	40	Natural



Splice Protector Colour Range	
No. of Colours	Colours
8	Brown, red, orange, yellow, green, blue, violet and grey
10	Black, brown, red, orange, yellow, green, blue, violet, grey and white





Copper Repair Closures
Copper Jointing Closures

Page
24
25-27

Snapseal™

The Snapseal™ is an environmentally sealed splice closure suitable for in-line and cap-ended jointing of copper telecommunication cables of up to 10 pair and CATV type co-axial cables. Co-axial cable connectors to a maximum size of RG6 (for which mounting lugs are provided) can also be accommodated within the compact design. It is ideally suited for installation in confined spaces, hazardous areas and repair situations. It consists of two shells manufactured from a tough engineering polymer, which are filled with a cured encapsulation gel (not grease). Any cable crimps or connections can be made and placed in one shell. The cables may then be securely anchored with cable ties at each end of the shell prior to being sealed. The second shell is then simply placed over the first and pressure applied until the joint snaps shut.

- Quick to fit and ideal for repairs
- Clean to use with no messy grease
- Suitable for installation in hazardous areas as no heat source is required
- Can be used for in-line and cap-ended applications
- Cable anchoring system using cable ties for easier, more secure installations
- Mounting holes for surface mounted applications
- Accommodates cables up to 10 pairs
- Accepts co-axial connectors up to RG6
- Tested to seal at 6 metres head of water
- Supplied with installation instructions and cable ties

Typical Applications

- Repair of copper telecommunication and CATV customer drop cables



Snapseal™ upper and lower shells



Closed Snapseal™

Snapseal™								
UNS No.	Reference	No. of Copper Pairs Max	Co-Axial Connector Size Max	Length (mm)	Width (mm)	Depth (mm)	Pack Size	Method of Sealing
857-10038	SNAPSEAL2553	10	RG6	180	32	32	1	Cured Gel

MRBU, RBU and LRBU Residential & Business Units

The MRBU, RBU and LRBU are a range of cap ended ready access closures used in the installation of copper telephony cables in both underground and aerial installations.

The 50 pair closure is available in two base configurations with a number of round ports and a central oval port for loop through applications whilst the 100 and 200 pair have a single base style only. The covers are environmentally sealed to the bases using a rolling "O" ring whilst the cables are sealed using either heatshrink sleeving or Cablelok™ non-heatshrink seals (see page 32) depending on the base configuration selected.

- Cablelok™ non-heatshrink cable sealing
- Multi-port base configurations
- Three sizes of closure for 50, 100 and 200 pair cables
- Suitable for both aerial and underground installations
- Approved to the UK Highways Agency environmental requirements
- All kits are supplied with cable surface preparation materials

Typical application

- The environmental housing of copper cable splices in underground or aerial installations

Accessories

- Pole or wall mounting bracket for all closures ACC1037 (see page 26)
- Port opening tools TPC1939, TPC1940, TPC1941, TPC 1942 and TPC3337 (see page 35)
- Cover release tool TCR1726 (see page 35)

Notes:

- MRBU1876 is supplied with 2 off B1 Cablelok™ seals
- MRBU1877 is supplied with 2 off R1, 1 off R2 and 1 off R3 Cablelok™ seals
- MRBU1878 is supplied with 1 off heat shrink sleeve for the oval port and 1 off heat shrink sleeve for the round ports
- Additional Cablelok™ seals and heatshrink sleeves can be purchased separately (see page 32 for details)

MRBU, RBU, LRBU Dimensions (mm)		
Closure Type	Length (mm)	Diameter (mm)
MRBU	310	110
RBU	269	130
LRBU	435	130

MRBU 50 Pair Port & Cable Details			
Port	No. of Ports	Cable Range (mm)	
		Cablelok™	Heatshrink
LM	1	2 x 9.5 - 22.0	2 x 8.0 - 22.0*
B	2 or 3	4.8 - 16.5	6.0 - 19.0
R	10 or 0	1.7 - 9.5	Not applicable

* Heatshrink on 4 port base only

MRBU 50 Pair Kits			
UNS No.	Reference	No. of Ports	Method of Sealing
857-10014	MRBU1876	4	Cablelok™
857-10015	MRBU1877	13	Cablelok™
857-10016	MRBU1878	4	Heatshrink



MRBU (50 pair)



RBU (100 pair)



LRBU (200 pair)

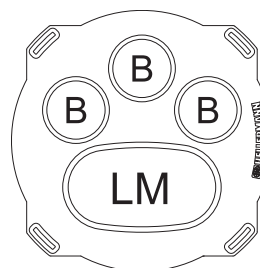

MRBU 4 port base
(Heatshrink & Cablelok™)

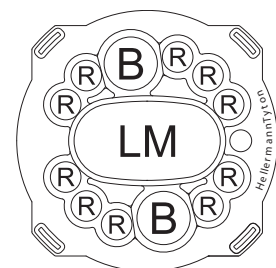

MRBU 13 port base
(Cablelok™ only)

LRBU Port & Cable Details			
Port	No. of Ports	Cable Range (mm)	
		Cablelok™	Heatshrink
L	1	2 x 12.5 - 21.5	2 x 12.0 - 24.0
B	4	4.8 - 16.5	6.0 - 19.0
R	4	1.7 - 9.5	4.0 - 11.0

RBU 100 Pair Kits			
UNS No.	Reference	No. of Ports	Method of Sealing
857-10025	RBU1887	9	Cablelok™
857-10027	RBU1889	9	Heatshrink
857-10028	RBU1890	9	Heatshrink

LRBU 200 Pair Kits			
UNS No.	Reference	No. of Ports	Method of Sealing
857-10009	LRBU2222	9	Cablelok™
857-10010	LRBU2223	9	Heatshrink
857-10011	LRBU2224	9	Heatshrink

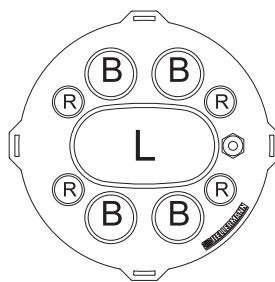

LRBU 9 port base



ACC1037 L/MRBU mounting bracket

Notes:

- RBU1887 and LRBU2222 are both supplied with 2 off B2 and 2 off R2 Cablelok™ seals
- RBU1889 and LRBU2223 are both supplied with a heatshrink sleeve pre-applied to the oval port and an additional sleeve 2 sleeves for the round ports
- RBU1890 and LRBU2224 are both supplied with 1 off heatshrink sleeve for the oval port and an additional 2 sleeves for the round ports

AUB – Amplifier Underground Box

The AUB is a pan type ready access environmentally sealed closure designed for the housing of compact amplifiers for CATV networks. Circular in shape, it has a row of 4 sealed cable entries, which allows ease of connection of the incoming and outgoing coaxial cables to the amplifier. The moulded cover is environmentally sealed to the base by using an "O" ring and stainless steel clamp assembly whilst sealing of the cables is achieved with either Cablelok™ non-heat shrink seals (see page 32 for further details) or heatshrink sleeves.

- BT Approved
- Ready access design
- 4 cable outlets for B series Cablelok™ or heatshrink sleeves
- Supplied with 2 x B2 Cablelok™ seals
- Suitable for underground or aerial installations
- Supplied with stainless steel fixing bracket for bearer mounting
- Suitable for compact Magnavox and Teletele amplifiers

Typical application

- For the underground housing of an amplifier in cable television networks (CATV)

AUB Kit	
UNS No.	Reference
857-10001	AUB2563PC

AUB Dimensions (mm)		
D1	D2	Height
330	400	146

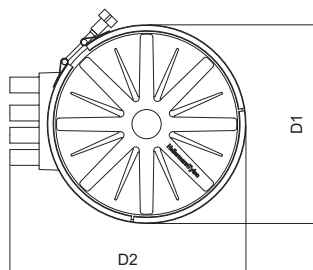

AUB2563PC



AUB & RBU in typical application

CDJ – Copper Distribution Joint

The CDJ closure is an oval shaped cap-ended ready access closure used for the organisation and protection of copper telephony cables in aerial, underground and directly buried installations. It is ideally suited for CATV applications due to the high number of customer cable drop ports.

It is available with a single base configuration having 52 round ports for the drop cables and 6 round ports for the main cables. The closure cover is sealed to the base using a rubber "O" ring and base quick release clamp whilst the cables are sealed using either heatshrink sleeving (with the exception of the 'R' drop ports) or Cablelok™ non-heatshrink seals on all ports.

The CDJ can be supplied either fully loaded with six 10 pair Channell rocker terminal blocks or empty so that the user can determine the method of copper termination.

- Quick release base to cover clamp
- High number of cable drop ports
- Available with Channell terminal blocks
- Cablelok™ only kits contain 2 off each R1, R2, R3, B1 and S2 Cableloks™
- Cablelok™ and heatshrink kits contain 2 off each R1, R2, R3 plus 4 off heatshrink sleeves for the round ports
- The kits are also supplied with cable surface preparation materials
- Additional Cablelok™ seals and heatshrink sleeves can be purchased seperately (see pages 32 and 33 for details)

Typical Applications

- CATV installations
- The environmental housing of copper cable splices in underground or aerial installations

Accessories

- Port opening tools TPC1941, TPC1942 TPC1943 and TPC3337 (see page 35)
- Wall mounting bracket FDNA3763 (UNS 857-40078) (see page 13 for photo)
- Stainless steel wall mounting strap kit ACC3334 (UNS 857-40042)
- FDN installation clamp FDNA3717 (see page 34)

CDJ Port and Cable Details			
Port	No. of Ports	Cable Range (mm)	
		Cablelok™	Heatshrink
L	1	2 x 13.0 - 22.0	2 x 12.0 - 24.0
T	2	15.5 - 29.0	12.0 - 35.0
S	4	5.0 - 20.0	12.0 - 26.0
B	2	4.8 - 16.5	6.0 - 19.0
R	52	1.7 - 9.5	-

CDJ Kits			
UNS No.	Reference	Terminal Blocks	Method of Sealing
857-10003	CDJ3701	6 x 10 pr Channell	Cablelok™
857-10004	CDJ3702	None	Cablelok™
857-10005	CDJ3703	6 x 10 pr Channell	Cablelok™ & Heatshrink
857-10006	CDJ3704	None	Cablelok™ & Heatshrink

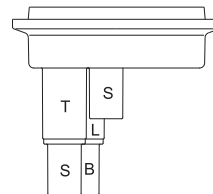
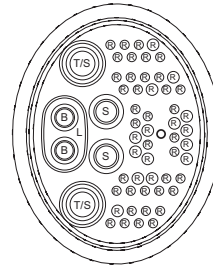

CDJ with Channell terminal blocks

CDJ Dimensions (mm)	
Length	Width
455	312/222



CDJ base configuration



	Page
Cablelok™ - Cable Sealing	30
Heatshrink Sleeving Kits	31
Installation Tools	32-33

Cablelok™

The CABLELOK™ seal is a unique and patented product used for the environmental sealing of cable entering a HellermannTyton cable jointing closure. Manufactured from an external grade of flexible neoprene, sealing is achieved by a number of internal lip seals, which are compressed onto the cable during installation.

The base port is opened using the correct size port opening tool (1) – see page 35. The cable is then simply inserted into the opened port (2) and then threaded through the Cablelok™ seal (3) so that sufficient cable is available for jointing. The Cablelok™ seal and cable are then pulled back together through the port (4) until the location shoulder of the seal locks against the open end of the port.

The photographs opposite illustrate the assembly steps.

- Excellent sealing properties to 6m head of water
- Rapid and consistent installation with few specialist tools as compared with heatshrink
- Ideal for use in hazardous areas as no heat is required for installation
- Dual outlet versions for loop through applications
- Multi-hole versions are available allowing several cable drops from the same port
- Supplied with lubricant impregnated wipes to assist installation
- Cablelok™ hole plugs are available for sealing unused outlets in multi-hole versions



(1) Punch out base hole with port tool (2) Feed through cable



(3) Slide on Cablelok™ seal (4) Pull back to correct position

Cablelok™ 'R' Series				
UNS No.	Reference	Cable Range (mm)	Size	Pack Qty
857-50085	CABLELOK3755	1.7 - 2.0	R8	50
857-50064	CABLELOK3598	2 x 1.7 - 2.0	R7	50
857-50123	CABLELOK3873	3.0 - 3.8	R9	50
857-50007	CABLELOK1078	2 x 3.8 - 4.8	R5	50
857-50009	CABLELOK1080	3.8 - 5.2	R1	50
857-50010	CABLELOK1081	5.2 - 8.0	R2	50
857-50011	CABLELOK1082	8.0 - 9.5	R3	50
857-50012	CABLELOK1083	Port Closure Plug	R4	50

Cablelok™ 'B' Series				
UNS No.	Reference	Cable Range (mm)	Size	Pack Qty
857-50029	CABLELOK2952	4.8 - 9.0	B4	25
857-50013	CABLELOK1084	8.0 - 14.0	B1	25
857-50014	CABLELOK1085	13.0 - 16.5	B2	25
857-50015	CABLELOK1086	Port Closure Plug	B3	25

Cablelok™ 'S' Series				
UNS No.	Reference	Cable Range (mm)	Size	Pack Qty
857-50124	CABLELOK3874	5.0 - 8.5	S6	20
857-50021	CABLELOK1969	8.0 - 12.0	S1	20
857-50065	CABLELOK3601	2 x 10.0 - 11.5	S5	20
857-50022	CABLELOK1970	12.0 - 16.0	S2	20
857-50023	CABLELOK1971	16.0 - 20.0	S3	20
857-50024	CABLELOK1972	Port Closure Plug	S4	20

Cablelok™ 'T' Series				
UNS No.	Reference	Cable Range (mm)	Size	Pack Qty
857-50066	CABLELOK3602	15.5 - 22.0	T5	10
857-50067	CABLELOK3603	20.5 - 23.5	T1	10
857-50068	CABLELOK3604	23.5 - 25.5	T2	10
857-50069	CABLELOK3605	24.5 - 29.0	T3	10
857-50070	CABLELOK3606	Port Closure Plug	T4	10

Installation Time

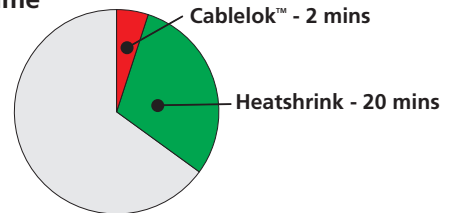

Cablelok™ 'LM' Series				
UNS No.	Reference	Cable Range (mm)	Size	Pack Qty
857-50018	CABLELOK1960	2 x 9.5 - 11.5	LM1	15
857-50071	CABLELOK3607	2 x 12.0 - 14.5	LM1A	15
857-50019	CABLELOK1961	2 x 17.5 - 18.5	LM2	15
857-50072	CABLELOK3609	2 x 18.5 - 22.0	LM2A	15
857-50020	CABLELOK1962	Port Closure Plug	LM3	15

Cablelok™ 'L' Series				
UNS No.	Reference	Cable Range (mm)	Size	Pack Qty
857-50016	CABLELOK1087	2 x 13.0 - 14.5	L1	10
857-50017	CABLELOK1088	2 x 16.5 - 18.0	L2	10
857-50008	CABLELOK1079	2 x 20.0 - 22.0	L3	10

Cablelok™ Hole Plug					
UNS No.	Reference	Nominal Dia. (mm)	Length (mm)	For use with	Pack Qty
857-50116	PLUG3610	2.00	150	R7	100
857-50117	PLUG3612	4.50	150	R5	100
857-50118	PLUG3613	10.50	200	S5, LM1	50
857-50119	PLUG3614	14.50	200	L1, LM1A	50
857-50120	PLUG3615	17.50	220	LM2, L2	25
857-50121	PLUG3616	20.00	200	LM2A, L3	25

KJC – Kits Joint Closure

The KJC No.1 range are environmentally sealed in-line closures used for the jointing of 20, 50 and 100 pair copper cables in underground and aerial installations. They consist of a length of adhesive lined medium walled heatshrink sleeving, aluminium foil to resist moisture penetration and a braided metal sleeve for strength and protection of the splice bundle.

- Manufactured and approved to the BT specification
- Medium walled heatshrink sleeving with thermochromatic paint for correct shrinkage temperature indication
- Metal braid for splice bundle protection
- Moisture penetration barrier foil
- Suitable for 20, 50 and 100 pair copper telecommunication cables with up to 0.9mm diameter conductors
- Thick layer of adhesive lining on the heatshrink sleeving for branch cable sealing
- Supplied with cable surface preparation materials



Typical Application

- The jointing of multi-conductor copper telecommunication cables in both aerial and underground installations

KJC Details						
UNS No.	Reference	No. of Pairs	Expanded Dia. (mm)	Recovered Dia. (mm)	Length (mm)	Splice Bundle Max. Length (mm)
857-40151	KJC1A257	20	28	6	600	230
857-40152	KJC1B258	50	45	12	600	230
857-40153	KJC1C259	100	60	16	600	230

HS – Heatshrink Sleeving

HS is a range of adhesive lined crosslinked polyolefin medium walled heatshrink sleeving used for sealing cable entries of external jointing closures for both fibre and copper cables. A selection of standard diameters and lengths are shown below but special lengths can be supplied to customer order.

The sleeves have an external coating of thermochromatic paint, which changes colour when the correct temperature for shrinkage is achieved and an internal lining of hot melt adhesive which provides the environmental seal.

- Meets the requirements of BT specification LN450
- Available in a range of sizes
- High shrink ratio
- Thermochromatic paint for correct shrinkage temperature indication
- Suitable for branch sealing applications
- HS kits are supplied with abrasive strips, aluminium foil and tissue wipes

Typical Application

- The sealing of cable entries on external cable jointing closures

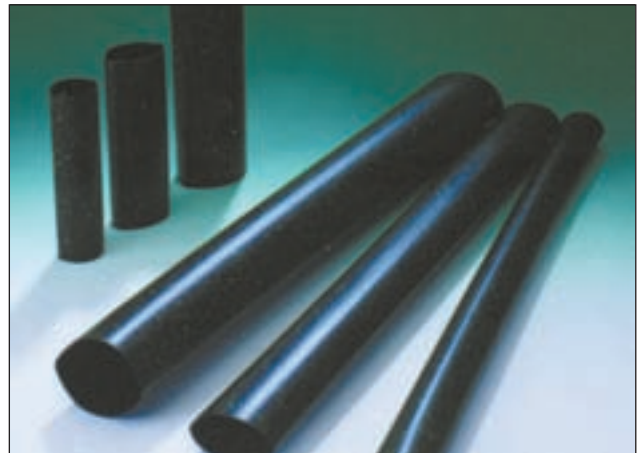

HS Details					
UNS No.	Reference	Expanded Dia. (mm)	Recovered Dia. (mm)	Length	Pack Qty
857-40142	HS1899	28	6	150	10
857-40143	HS1900	28	6	180	10
857-40144	HS1901	28	6	600	10
857-40145	HS1902	45	12	150	10
857-40146	HS1903	45	12	180	10
857-40147	HS1904	45	12	600	10
857-40148	HS1905	60	16	150	10
857-40149	HS1906	60	16	180	10
857-40150	HS1907	60	16	600	10

BCL - Branch Cable Sealing Clip

The BCL is a 65mm long 'U' shaped black epoxy coated aluminium clip. It is used in conjunction with an adhesive lined heatshrink sleeve to produce an environmental seal between two cables passing through the same port of a closure.

- Simple design allows for rapid heat transfer through the heatshrink sleeve to the hot melt adhesive lining
- One size of clip accommodates a wide range of cable diameters for 5 to 28mm

Typical Applications

- The branch sealing between two cables on a closure
- Loop through fibre applications using heatshrink seals

Branch Cable Sealing Clip		
UNS No.	Reference	Pack Size
857-40063	BCL1938	50



Universal Installation Mounting Bracket

The universal Installation Mounting Bracket is designed for securing various closure types in the horizontal and vertical positions during installation of network cables or closure maintenance.

- Provides secure closure fixture
- Each size covers a number of closure types
- Vertical or horizontal orientations possible
- Simple, quick and safe to use
- Manufactured from high quality materials for long service life
- Interchangeable jaws to cover all HellermannTyton cap-ended closures

Typical Applications

- Cable Installation
- Splicing and maintenance

Universal Installation Mounting Bracket			
UNS No.	Reference	Description	For Closure Type
857-40181	UFCA2685	Complete Bracket	UFC, FML, FDN, CDJ
857-40110	FRBUA2820	Complete Bracket	FRBU, FST, MRBU, RBU, LRBU
857-40077	FDNA3717*	Complete Bracket	FDN
857-40015	ACC2823	Jaws Only	UFC, FML, FDN, CDJ
857-40016	ACC2824	Jaws Only	FRBU, FST, MRBU, RBU, LRBU

*Economy version - FDN only



ACC2824 - Jaws Only



UFCA2685 - Vertical Position

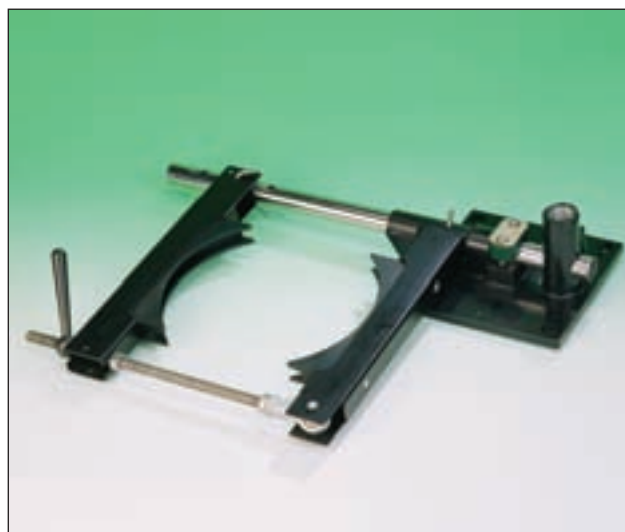

UFCA2685 - Horizontal Position

TPC – Port Opening Tools

The TPC range of tools is available in a number of sizes designed for the removal of the ends of closed cable entry ports on the HellermannTyton range of ready access closures.

There are two types of tool, one for the “top hat” style ends of the 4 port FST, FRBU, MRBU, RBU and LRBU and the other for the inset disc style ends of the 11 and 13 port FST, FDN, FML and UFC.

In order to open up the cable entry ports, both types of tool are located at the end of the port and rotated several times by hand cutting through the material leaving a smooth finish for cable installation.

- Consistent smooth quality of cut reducing risk of damage to cable sheaths during installation
- Ideal for Cablelok™ installations
- Simple, quick and safe to use
- Manufactured from high quality materials for long service life

Typical Application

- The removal of cable port entries of ready access closures

Inset Disc Style Tools			
UNS No.	Reference	Pack Qty	Port Size
857-40175	TPC1941	1	R
857-40176	TPC1942	1	B
857-40177	TPC1943	1	S



Inset disc style tool



'Top Hat' style tool

Top Hat Style Ports			
UNS No.	Reference	Pack Qty	Port Size
857-40173	TPC1939	1	R
857-40174	TPC1940	1	B

Coping Saw			
UNS No.	Reference	Pack Qty	Port Size
857-40179	TPC3337	1	L, LM, T

TCR – Cover Release Tools

The TCR tools are supplied in pairs and are re-usable hand operated tools manufactured from stainless steel. They are designed to aid the opening of the FST, FRBU, MRBU, RBU and LRBU ready access closures.

The tongues of the tools are simply applied between the base and the cover and act so as to lever the cover retaining lugs from the base in order to open the closure.

- Easy to use and prevents the possibility of damage to the closure
- Manufactured from stainless steel and re-usable

Typical Application

- The opening of FST, FRBU, MRBU, RBU and LRBU ready access closures



Cover Release Tool		
UNS No.	Reference	Pack Size
857-40172	TCR1726	2

AUB - Amplifier Box Closure	26
BCL - Branch Cable Sealing Clip	32
BFJ - Blown Fibre Joint	20
BFP - Building Flexibility Point	10
Cablelok™	30
CDJ - Copper Distribution Joint	27
CPU - Customer Premise unit	10
FDN - Fibre Distribution Node	14
FDN with Hellipse™ NZDF-A Trays	14
FDN with Hellipse™ SMF Trays	14
FM - Manifolds and Adaptors	21
FML - Fibre Modular Link	16
FML with Hellamass™ - Large Trays	17
FML with Hellapon™ - Medium Trays	17
FML with Hellipse™ NZDF SE-B Trays	17
FRBU - Fibre Residential and Business Unit	12
FRBU Hinged with Hellapon™ - Medium Tray	13
FRBU Stacked with Hellapon™ - Medium Tray	13
FRBU with Hellapon™ - Small Tray	13
FSP - Splice Protectors	21
FST - Fibre Small Tray	11
FST with Hellacurve™ Tray	11
FST with Hellapon™ - Small Tray	11
Hellacurve™	6
Hellafos™	7
Hellamass™ - Large	8
Hellapon™ - Medium	6
Hellapon™ - Small	6
Hellipse™ - SMF	8
Hellipse™ NZDF SC-1	8
Hellipse™ NZDF SE-A	7
Hellipse™ NZDF SE-B	7
HS - Heatshrink Sleeving	31
Inserts - Splice Protectors	9
KJC - Kits Joint Closure	31
Manifolds	21
MRBU, RBU and LRBUS Residential & Business Units	25
PLC - Power Line Closure	15
Snapseal™	24
TCR - Cover Release Tools	33
TPC - Port Opening Tools	33
UFC - Universal Fibre Closure	18
UFC with Hellamass™ - Large Trays	19
UFC with Hellipse™ SMF Trays	19
UFC with Hellipse™ NZDF-A Trays	19
Universal Installation Mounting Bracket	32

Where ever you need us...

you can find us at a place near you. You can use our combined global know-how to derive your solution.



HellermannTyton

<http://www.htdata.co.uk>

HellermannTyton - Argentina

Monteagudo 760
(1672) Villa Lynch
Province of Buenos Aires
Argentina
Tel: +541 14754 5400
Fax: +541 14752 0374

HellermannTyton - Australia

HT Australia
Units 2 & 3
12-14 Mangrove Lane
Taren Point
New South Wales 2229
Australia
Tel: +61 295 252133
Fax: +61 295 262495

HellermannTyton - Austria

HellermannTyton GmbH
Obachgasse 6
A-1221 Vienna
Austria
Tel: +43 1 259 99 55
Fax: +43 1 259 99 11

HellermannTyton - Brazil

HellermannTyton Ltda
Av. José Benassi, 100
Parque Industrial
Jundiaí - SP
Brazil
CEP 13213-085
Tel: +5511 4815 9040
Fax: +5511 4815 9029

HellermannTyton - Canada

Beaver Creek Business Park
160 West Beaver Creek
Unit 1, Richmond Hill
Ontario L4B 1B4
Canada
Tel: +1 905 726 1221
Fax: +1 905 882 1624

HellermannTyton - China

(Wuxi) Electrical Accessories Co.
Ltd
Suite 703, 7/F, Tower 1
Kerry Everbright City
No. 218, Tian Mu Xi
Shanghai
China 200070
Tel: +8621 6317-4245
Fax: +8621 6317-5273

HellermannTyton - Czech Republic

HellermannTyton
Litovská 28
CZ-779 00 Olomouc
Tel: +420 508 393231
Fax: +420 508 393694

HellermannTyton - Denmark

Baldersebuen 53
2640 Hedehusene
Denmark
Tel: +45 70 23 71 20
Fax: +45 70 23 71 21

HellermannTyton - Finland

Sahkotie 8
Fin-01510 Vantaa
Finland
Tel: +358 9 8700 450
Fax: +358 9 8700 4520

HellermannTyton - France

Miniparc du Manet
2 rue des Hetres
BP 130, 78196 Trappes Cedex
France
Tel: +33 1 30 13 80 00
Fax: +33 1 30 13 80 60

HellermannTyton - Germany

Großer Moorweg 45
25436 Tornesch
Germany
Tel: +49 4122 7011
Fax: +49 4122 701400

HellermannTyton - Hong Kong

Rooms 1802
3, Olympia Plaza
No. 255 King's Road
NorthPoint
Hong Kong
Tel: +852 2831 9090
Fax: +852 2832 9381

HellermannTyton - Hungary

HellermannTyton Kft.
Kisfaludy u. 13, H-1047
Budapest
Hungary
Tel: +36 1 369 41 51
Fax: +36 1 369 41 51

HellermannTyton - Ireland

Unit 77
Cherry Orchard Industrial Estate
Ballyfermot
Dublin 10
Ireland
Tel: +353 1 626 8267
Fax: +353 1 626 8022

HellermannTyton - Italy

Via Praimbole 9 Bis
35010 Limena PD
Padua
Italy
Tel: +39 049 767 870
Fax: +39 049 767 985

HellermannTyton - Japan

HellermannTyton
9F Ebisu Prime Square Tower
1-1-39 Hiroo
Shibuyaku
Tokyo 150-00-12
Japan
Tel: +813 5468 1771
Fax: +813 5468 1772

HellermannTyton - Mexico

Rio Conchos 1757
Industrial El Rosario
Guadalajara
Jalisco
Mexico
44890
Tel: +52 3 659 7020
Fax: +52 3 659 6939

HellermannTyton - Netherlands

HellermannTyton B.V.
Vanadiumweg 11-c
NL-3812 PX Amersfoort
Netherlands
Tel: +31 (0) 33 460 06 90
Fax: +31 (0) 33 460 0699

HellermannTyton - Norway

Stromsveien 177
PO Box 240 Alnabru
N-0614 Oslo
Norway
Tel: +47 2 317 4700
Fax: +47 2 297 0970

HellermannTyton - Philippines

Unit 2107
88 Corporate Center
Sedeno cor Valero Street
Salcedo Village
Makati City
Tel: (+632) 752 6551/2
Fax: (+632) 752 6553

HellermannTyton - Poland

HellermannTyton
Oddzial w Polsce
ul. Meissnera 9/28
PL-03 982 Warszawa
Poland
Tel: +48 22 673 89 54
Fax: +48 22 673 89 54

HellermannTyton - Portugal

Rangel
Rua da Serra, 654
4446-909
Folgosa Maia
Portugal
Tel: 00 351 22 968 7636
Fax: 00 351 22 968 7634

HellermannTyton - Romania

HellermannTyton
Str. Stirbei Voda nr. 95
Sector 1, 77104
Bucharest - Romania
Tel: +40 21 310 4445
Fax: +40 21 310 4445

HellermannTyton - Singapore

545 Yishun Industrial Park A
Yishun Ave 7
Singapore 768741
Tel: +65 6852 8585
Fax: +65 6756 6798

HellermannTyton - Slovenia

HellermannTyton GmbH
Prodruznica Ljubljana
Trubarjeva 79
SI-1101 Ljubljana
Slovenia
Tel: +386 1 4337056
Fax: +386 1 4336321

HellermannTyton - South Africa

HellermannTyton
Private Bag X158
Rivonia
Johannesburg 2128
South Africa
Tel: +27 11 879 6651
Fax: +27 11 879 6605

HellermannTyton - South Korea

HellermannTyton Pte Ltd
Korea Office, Room 3321
Madong, ChungAng Circulation
Complex # 1258
Kurobon-Dong
Kuro-Ku
Seoul 152-721 Korea
Tel: +82-2-2614-0157
Fax: +82-2-2614-0284

HellermannTyton - Spain

HellermannTyton España, S.L.
C/ Jose Echegaray, 4
P. Emp. Casablanca 1. Edif. BI 2º
28100 Alcobendas (Madrid)
Spain
Tel: 00 34 91 661 28 35
Fax: 00 34 91 661 23 68

HellermannTyton - Sweden

HellermannTyton AB
Datavägen 5
Box 569
175 26 Järfälla
Sweden
Tel: +46 8 580 890 00
Fax: +46 8 580 890 01

HellermannTyton - Thailand

10th Floor Sitthivorakit Building
5 Soi Pipat, Silom Road
(Bangkok)
Bangkok 10500
Thailand
Tel: +662 237 6702
Fax: +662 266 8664

HellermannTyton - USA

7930 North Faulkner Road
PO Box 245017
Milwaukee
Wisconsin 53224
United States
Tel: +1 414 355 1130
Fax: +1 414 355 7341

HellermannTyton - UK

(Cable Accessories - Fixings)
Sharston Green Business Park
1 Robeson Way
Altrincham Road
Wythenshawe
Manchester M22 4TY
United Kingdom
Tel: +44 161 945 4181
Fax: +44 161 945 3708

HellermannTyton - UK

(Distribution to Electrical Wholesale-
sellers)
Wharf Approach
Aldridge
Walsall
West Midlands WS9 8BX
United Kingdom
Tel: +44 1922 458151
Fax: +44 1922 743237

Your Distributor:

HellermannTyton

HellermannTyton
Broadband Systems Division
Cornwell Business Park
Salthouse Road
Brackmills
Northampton
NN4 7EX
Tel: +44 (0) 1604 707420
Fax: +44 (0) 1604 705454
E-Mail: sales@htdata.co.uk